

COLLECTIONS

2024







GENERAL CATALOGUE
2024

MEGAKER

INDEX BY MATERIAL

CALACATTA SURFACES **CL-006**
 Matt / Lappato / Glossy Polished / Honed Page. 026
 PORCELAIN TILES

CONCRETE SURFACES **CN-004**
 Matt Page. 028
 PORCELAIN TILES

CN-005
 Matt Page. 030

CN-006
 Matt Page. 032

CN-007
 Matt Page. 034

CN-008
 Lappato Page. 036

CN-009
 Matt Page. 038

FABRIC SURFACES **FB-005**
 Matt Page. 040
 PORCELAIN TILES

GRANITE SURFACES **GR-004**
 Matt Page. 042
 PORCELAIN TILES

GR-005
 Matt Page. 044

MARBLE SURFACES **MB-005**
 Matt Page. 046
 PORCELAIN TILES

MB-006
 Glossy Polished Page. 048

METAL SURFACES **ME-004**
 Matt / Lappato Page. 050
 PORCELAIN TILES

ME-005
 Lappato Page. 052

ONYX SURFACES **OX-003**
 Glossy Polished Page. 054
 PORCELAIN TILES

STONE SURFACES **ST-031**
 Matt Page. 056
 PORCELAIN TILES

ST-032
 Matt Page. 058

ST-033
 Matt Page. 060

ST-034
 Matt / Glossy Polished Page. 062

ST-035
 Matt / Glossy Polished Page. 064

ST-036
 Matt / Glossy Polished Page. 066

ST-037
 Matt / Glossy Polished Page. 068

ST-038
 Glossy Polished Page. 070

ST-039
 Matt / Glossy Polished Page. 072

ST-040
 Matt / Glossy Polished Page. 074

ST-041
 Matt Page. 076

ST-042
 Matt Page. 078

ST-043
 Matt Page. 080

ST-044
 Matt / Glossy Polished Page. 082

ST-045
 Matt / Glossy Polished Page. 084

ST-046
 Matt / Glossy Polished Page. 086

ST-050
 Matt Page. 088

WOOD SURFACES **WD-004**
 Matt Page. 090
 PORCELAIN TILES

INDEX BY SIZE

	160x320	120x310	120x280	120x260	160x160	120x120
CALACATTA SURFACES CL-006 Page. 026	•	•	•	•	•	•
CONCRETE SURFACES CN-004 Page. 028		•	•	•		
CN-005 Page. 030		•	•	•		
CN-006 Page. 032				•		
CN-007 Page. 034		•	•	•	•	•
CN-008 Page. 036		•	•	•		•
CN-009 Page. 038	•	•	•			
FABRIC SURFACES FB-005 Page. 040			•			
GRANITE SURFACES GR-004 Page. 042			•	•		•
GR-005 Page. 044				•		•
MARBLE SURFACES MB-005 Page. 046				•		
MB-006 Page. 048		•	•			•
METAL SURFACES ME-004 Page. 050				•		
ME-005 Page. 052				•		
ONYX SURFACES OX-003 Page. 054	•	•	•	•	•	•
STONE SURFACES ST-031 Page. 056				•		•
ST-032 Page. 058		•	•			
ST-033 Page. 060				•		
ST-034 Page. 062	•	•	•	•	•	

	160x320	120x310	120x280	120x260	160x160	120x120
ST-035 Page. 064	•	•	•	•	•	
ST-036 Page. 066	•	•	•	•	•	•
ST-037 Page. 068	•	•	•	•	•	•
ST-038 Page. 070		•	•			
ST-039 Page. 072	•	•	•			
ST-040 Page. 074	•	•	•			
ST-041 Page. 076				•		•
ST-042 Page. 078		•	•	•		
ST-043 Page. 080		•	•	•		
ST-044 Page. 082		•	•	•		•
ST-045 Page. 084	•	•	•	•		
ST-046 Page. 086	•	•	•	•	•	
ST-050 Page. 088		•	•			
WD-004 Page. 090			•			

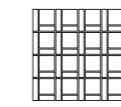

Forma Concept 3
33cm x 33cm

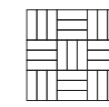

Forma Concept 5
33cm x 33cm

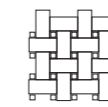

Forma Concept 36
33cm x 33cm

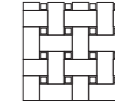

Forma Concept 42
33cm x 33cm

CL-006
Page. 026

	•				
--	---	--	--	--	--

ME-004
Page. 050

•					
---	--	--	--	--	--

OX-003
Page. 054

		•			
--	--	---	--	--	--

ST-032
Page. 058

	•				
--	---	--	--	--	--

ST-035
Page. 064

				•	
--	--	--	--	---	--

SUSTAINABLE TILES

As part of Megaker culture and goals, the care for the world heritage is a must. Megaker production philosophy is based on quality and innovation, with special attention to the environment using the latest technologies.

Megaker believes that to protect the environment for future generations must accept some responsibility for maintaining the planet. Therefore, it is our duty to prevent environmental degradation and work in conditions in a way to ensure the health of workers and the nature at the same time.

The preservation of environment is constantly a priority of Spainker from the moment we select our raw materials, up until the moment the finished ceramic tiles are dispatched from our warehouse.



HIGH PERFORMANCE TILES

We understand that our parts must be unique and irreplaceable, looking to the future, we wanted to design a smart material, a product without limitations or restrictions for the most demanding architecture, capable of adapting to the most special projects. The diversity of big formats of these pieces allows covering the space from floor to ceiling with a single piece, creating an infinity effect to the eye.

The full body porcelain tile delivers certain advantages vs other collections, without losing all benefits the glaze porcelain offers, its main feature resides in its inside. The raw material that shapes the tile become uniform without any superficial decoration that delivers the same aesthetic throughout the tile, this particularity make it the best fit for all those spaces that demand the most hard wearing materials.



FULL BODY Technology

Megaker introduces an innovative technology that allows to design the core of the parts from the custom selection of each of its components, combined in different proportions, colours and gradients. The core design is a fundamental part of the surface appearance of the part, allowing it to look like a complete piece and achieving impeccable consistency between the surface, the interior and the edges. This fact dramatically increases the potential for producing worktops and decorative surfaces with visible edges.



DIGITAL STRUCTURE Technology

Our collections with 3D-Fit® textures use an innovative 3D digital graphic printing technique. This process allows the image and textures of the ceramic to work seamlessly together, so that, together with the core designed using this technology, it creates a much more realistic looking surface and gives each piece a unique and special character.

With materials like wood or stone, this effect could only be achieved if the texture and graphics were intrinsically linked. Now, as a result of our RDI, 3D-Fit® can be applied to a selection of our Series. The highest level of definition to make each surface appear much more realistic.



3D-Fit®
Technology

Glossy Polished

With a high-gloss, perfectly smooth finish, the polished surface exhibits a full range of tones. A gloss that does not scratch the surface of the tile, does not fade or show signs of wear.

Matt

Matte finished is covered in a non-shiny glaze that is applied with an ink jet machine or in a waterfall stream glazing method. This process yields tiles with a flat finish that do not reflect light and offer a contemporary look.

Anti-Slip

Our new anti-slip finish presents a new smoother appearance, while maintaining all the properties that guarantee total user safety to be used on outdoor surfaces and wet areas, such as the edges of swimming pools or snow and rain climates.

Honed

Surface finish with a soft and pleasant touch, made by lapping that respects the digital texture of the piece, which coincides with its graphic and gives a great realism to the surface of the material.

Lappato

Lappato finished is basically a shiny texture that is added to the surface of the tile to give it a semi gloss appearance. Depending on the viewing angle, the light dances on the surfaces or disappears on the matt textures.





All our collections suggest a rich blend of materials and finishes. They are designed as a whole, so that they are easy to combine with each other, regardless of the line and the chromatic choice. All the collections are found in a wide range of formats, responding to the contemporary architecture's demands and allowing almost infinite combinations. We have used current technologies such as ceramic color digital printing, and technology forefront methods such as directly printing on the glazing and "mascaring", which have enabled us to create light and beautiful designs with great personality and with unprecedented finishes and textures.

DISCOVER OUR COLLECTIONS

PORCELAIN TILES



CL-006 WHITE LAPPATO
120cmx280cm



CN-007 GREEN MATT
120cm x 280cm



FB-D-005 MATT
120cmx310cm



GR-004 GREY MATT
120cm x 280cm



OX-003 GREEN GLOSSY POLISHED
120cmx280cm



ST-034 BLUE MATT
160cm x 320cm



ST-035 GREEN MATT
120cmx280cm



ST-036 BEIGE MATT
160cm x 320cm



ST-038 BLUE GLOSSY POLISHED
120cmx280cm



ST-039 BLUE MATT
120cmx280cm



ST-040 BLUE MATT
160cm x 320cm



ST-043 SAND MATT
120cm x 280cm



ST-045 LIGHT MATT
160cm x 320cm



ST-046 GREEN GLOSSY POLISHED
120cm x 280cm

CL-006

Calacatta

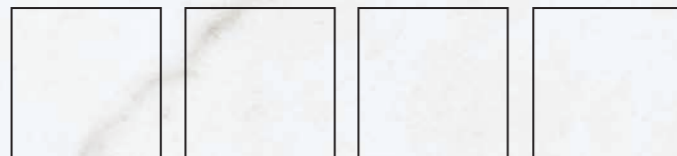

Glossy Polished Matt Lappato Honed

Porcelain Tile
Rectified
Destonified: V.2
Sizes: 160cm x 320cm / 120cm x 310cm / 120cm x 280cm / 120cm x 260cm / 160cm x 160cm / 120cm x 120cm

CL-006
Scale 1/2

Available Colours



White

QR Model Information:



Available Sizes:

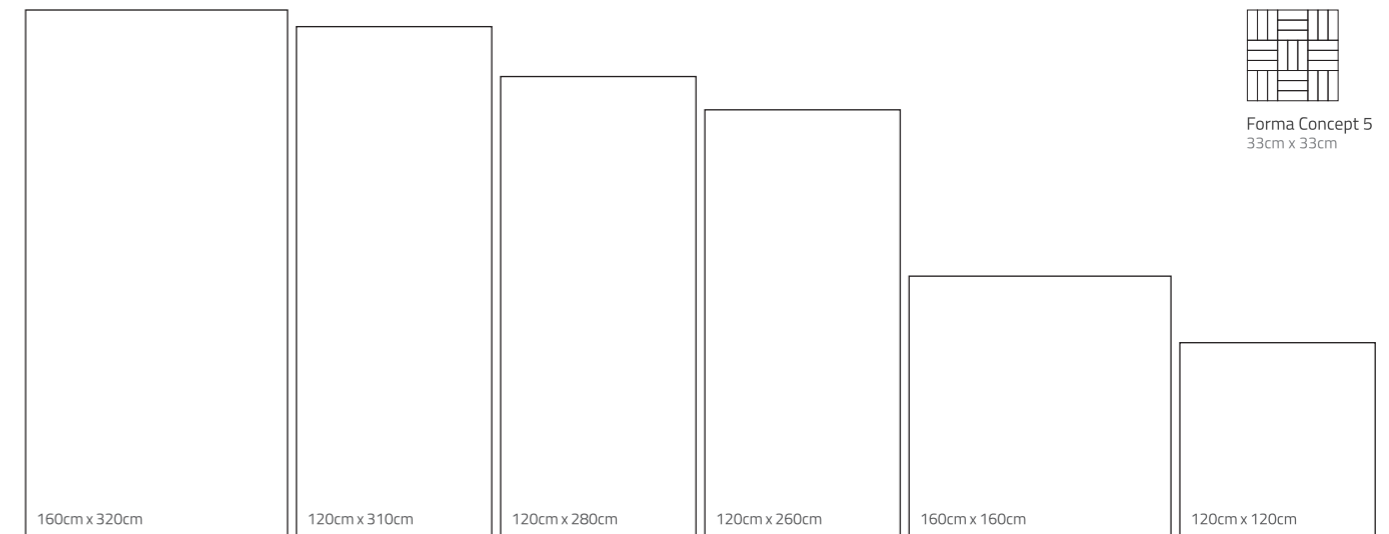

Complements:

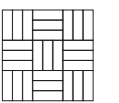

Forma Concept 5
33cm x 33cm

Available Sizes & Finishes:

Normal Size	Glossy Polished	Matt	Lappato	Honed	Box	Box M2	Box Kg	Pallet Pz	Pallet M2	Pallet Kg	Pallet Dimensions	Trolley Pallet	Trolley M2	Trolley Kg
160x320 - 0.9 cm	●	●	●	●	1	5.12	111	20	102.4	2357	337x177x52 cm	9	921.6	21213
120x310 - 0.9 cm	●	●	●	●	1	3.72	80	28	104.16	2390	327x137x60 cm	9	937.44	21510
120x280 - 0.9 cm	●	●	●	●	1	3.36	73	30	100.8	2322	297x137x62 cm	10	1008	23223.2
120x260 - 0.9 cm	●	●	●	●	1	3.12	67.5	33	102.96	2350	277x137x64 cm	10	1029.6	23500
160x160 - 1 cm	●	●	●	●	1	2.56	60	35	89.6	2200	177x177x71 cm	10	896	22000
120x120 - 1 cm	●	●	●	●	1	1.44	34	45	64.8	1620	137x137x83 cm	14	907.2	22680

CN-004

Concrete



Matt

Porcelain Tile
Rectified
Destonified: V,2
Sizes: 120cm x 310cm / 120cm x 280cm / 120cm x 260cm

CN-004 Light
Scale 1/2

Available Colours



Light Light Grey Dark Grey Cream Anthracite

* Color Body for Anthracite color.

QR Model Information:



Available Sizes:

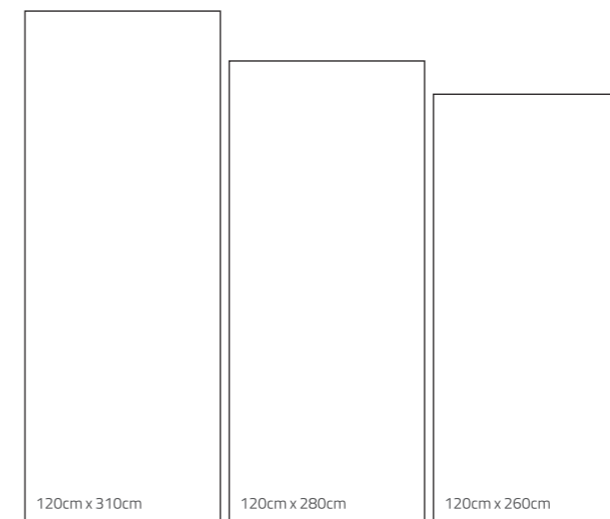

Available Sizes & Finishes:

Normal Size	Matt	Box	Box M2	Box Kg	Pallet Pz	Pallet M2	Pallet Kg	Pallet Dimensions	Trolley Pallet	Trolley M2	Trolley Kg
120x310 - 0,9 cm	●	1	3,72	80	28	104,16	2390	327x137x60 cm	9	937,44	21510
120x280 - 0,9 cm	●	1	3,36	73	30	100,8	2322	297x137x62 cm	10	1008	23223,2
120x260 - 0,9 cm	●	1	3,12	67,5	33	102,96	2350	277x137x64 cm	10	1029,6	23500

CN-005

Concrete



Matt

Porcelain Tile
Rectified
Destonified: V.2
Sizes: 120cm x 310cm / 120cm x 280cm / 120cm x 260cm

CN-005 Beige
Scale 1/2

Available Colours



Beige

Grey

Light

QR Model Information:



Available Sizes:

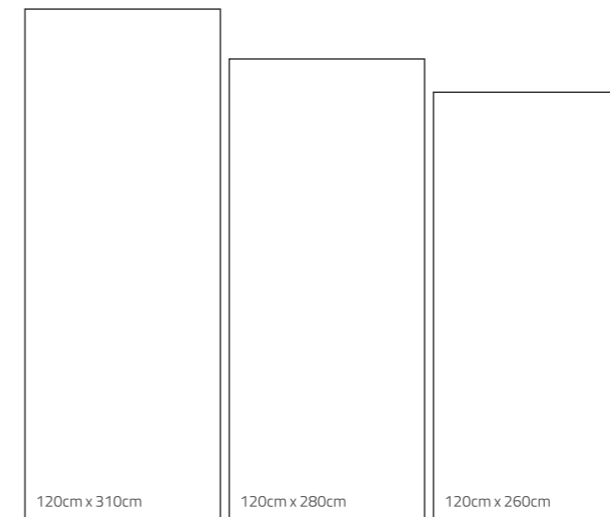

Available Sizes & Finishes:

Normal Size	Matt	Box	Box M2	Box Kg	Pallet Pz	Pallet M2	Pallet Kg	Pallet Dimensions	Trolley Pallet	Trolley M2	Trolley Kg
120x310 - 0,9 cm	●	1	3,72	80	28	104,16	2390	327x137x60 cm	9	937,44	21510
120x280 - 0,9 cm	●	1	3,36	73	30	100,8	2322	297x137x62 cm	10	1008	23223,2
120x260 - 0,9 cm	●	1	3,12	67,5	33	102,96	2350	277x137x64 cm	10	1029,6	23500

CN-006

Concrete

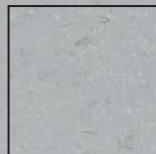

Matt

Porcelain Tile
Rectified
Destonified: V.2
Sizes: 120cm x 260cm

CN-006 Grey
Scale 1/2

Available Colours



White

Grey

Beige

Black

* Color Body for Black color.

QR Model Information:



Available Sizes:



120cm x 260cm

Available Sizes & Finishes:

Normal Size	Matt	Box	Box M2	Box Kg	Pallet Pz	Pallet M2	Pallet Kg	Pallet Dimensions	Trolley Pallet	Trolley M2	Trolley Kg
120x260 - 0.9 cm	●	1	3.12	67.5	33	102.96	2350	277x137x64 cm	10	1029.6	23500

CN-007

Concrete

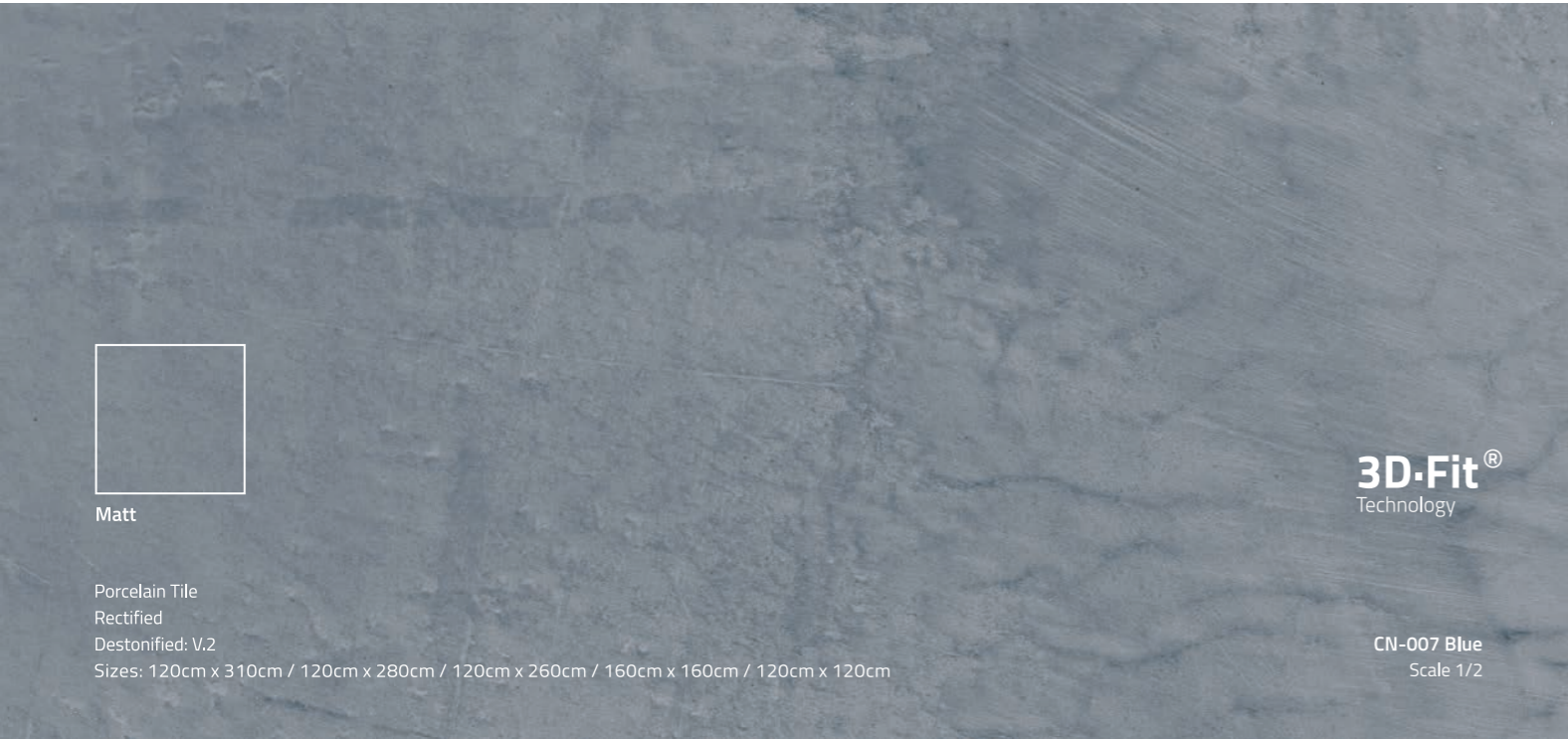

CN-D-007 Faces:



CN-D-007
120cm x310 cm

CN-D-007
120cm x310 cm

CN-D-007
120cm x310 cm

Available Sizes:

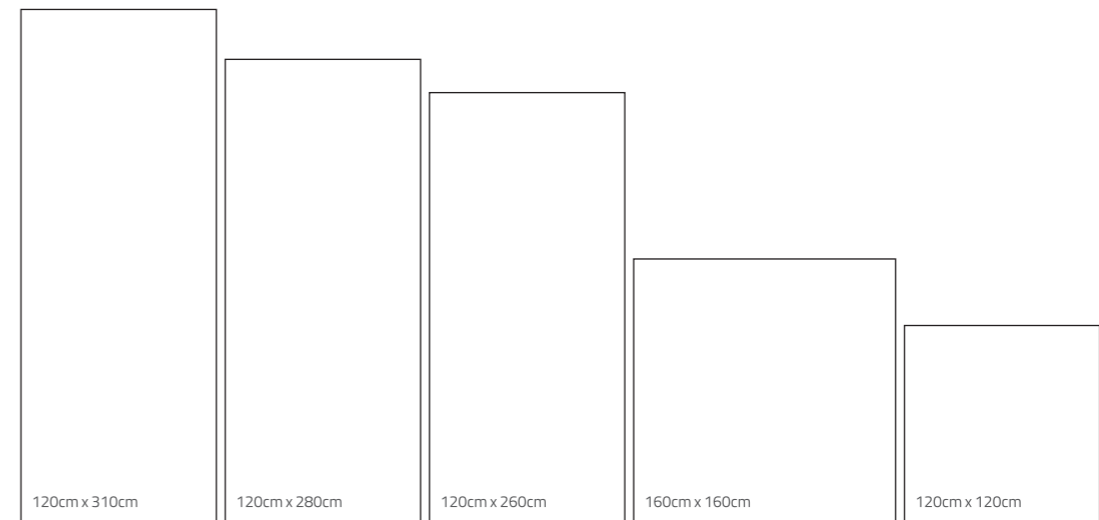

Available Colours



Blue

Green

Grey

Orange

QR Model Information:



Available Sizes & Finishes:

Normal Size	Matt	Box	Box M2	Box Kg	Pallet Pz	Pallet M2	Pallet Kg	Pallet Dimensions	Trolley Pallet	Trolley M2	Trolley Kg
120x310 - 0,9 cm	●	1	3,72	80	28	104,16	2390	327x137x60 cm	9	937,44	21510
120x280 - 0,9 cm	●	1	3,36	73	30	100,8	2322	297x137x62 cm	10	1008	23223,2
120x260 - 0,9 cm	●	1	3,12	67,5	33	102,96	2350	277x137x64 cm	10	1029,6	23500
160x160 - 1 cm	●	1	2,56	60	35	89,6	2200	177x177x71 cm	10	896	22000
120x120 - 1 cm	●	1	1,44	34	45	64,8	1620	137x137x83 cm	14	907,2	22680

CN-008

Concrete

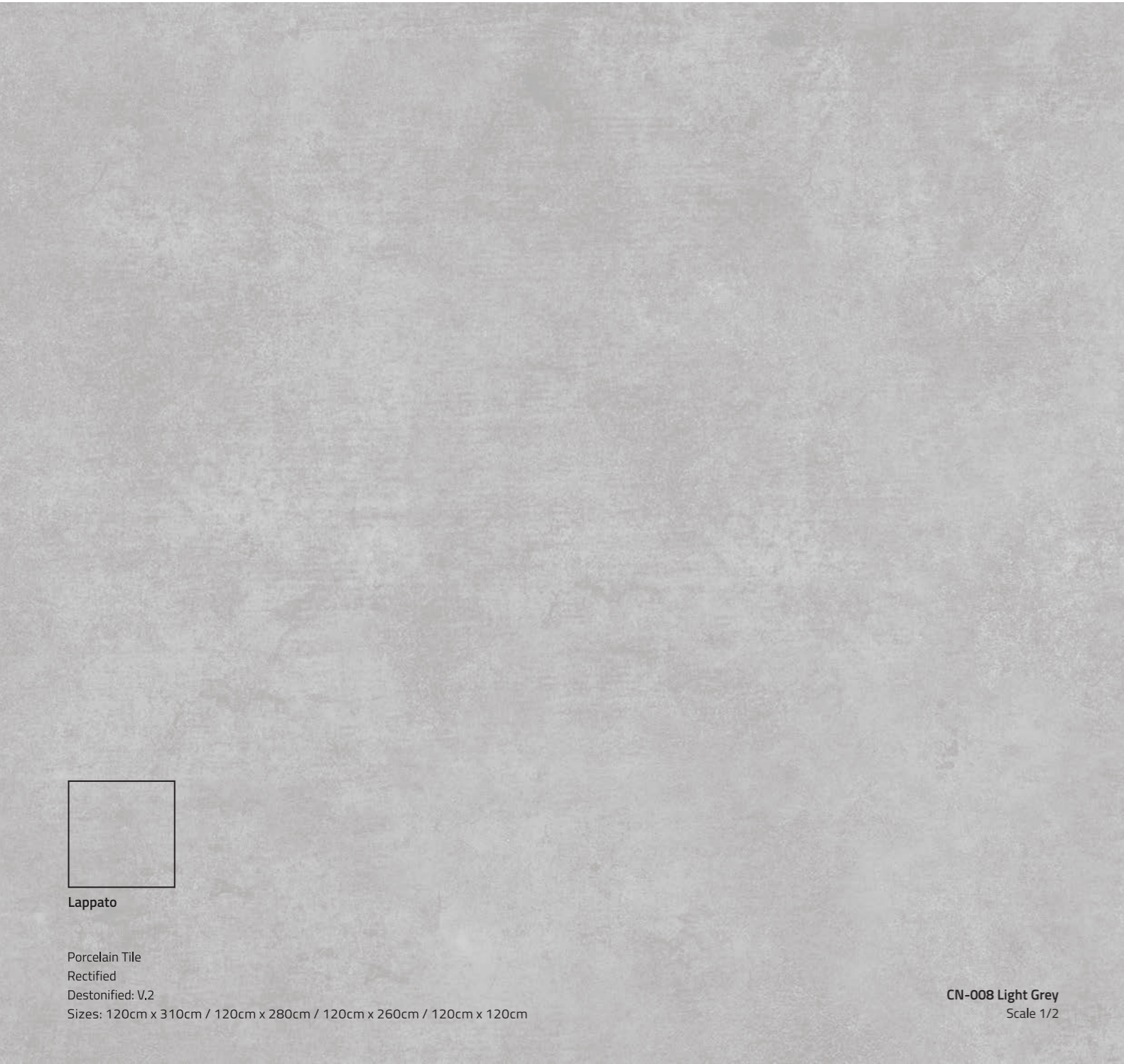

Lappato

Porcelain Tile
 Rectified
 Destonified: V,2
 Sizes: 120cm x 310cm / 120cm x 280cm / 120cm x 260cm / 120cm x 120cm

CN-008 Light Grey
 Scale 1/2

Available Colours



Light Grey Dark Grey Light Beige Dark Beige

QR Model Information:



Available Sizes:

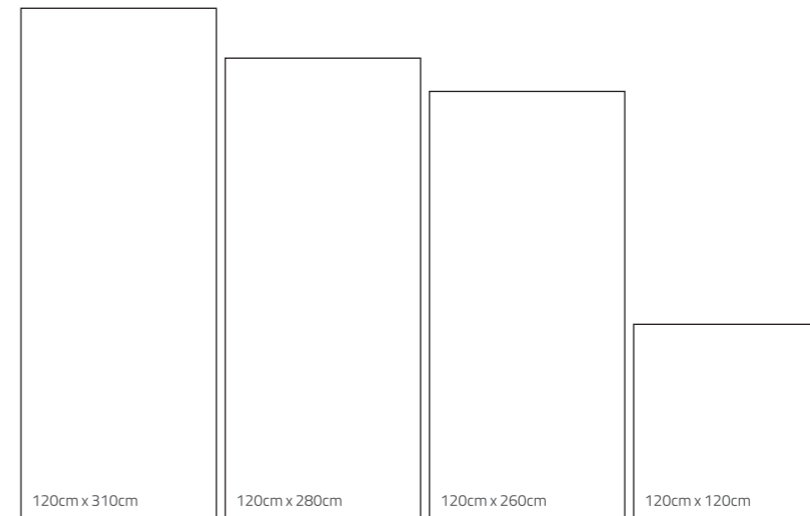

Available Sizes & Finishes:

Normal Size	Lappato	Box	Box M2	Box Kg	Pallet Pz	Pallet M2	Pallet Kg	Pallet Dimensions	Trolley Pallet	Trolley M2	Trolley Kg
120x310 - 0.9 cm	●	1	3.72	80	28	104.16	2390	327x137x60 cm	9	937.44	21510
120x280 - 0.9 cm	●	1	3.36	73	30	100.8	2322	297x137x62 cm	10	1008	23223.2
120x260 - 0.9 cm	●	1	3.12	67.5	33	102.96	2350	277x137x64 cm	10	1029.6	23500
120x120 - 1 cm	●	1	1.44	34	45	64.8	1620	137x137x83 cm	14	907.2	22680

CN-009

Concrete



Matt

Porcelain Tile
Rectified
Destonified: V,2
Sizes: 160cm x 320cm / 120cm x 310cm / 120cm x 280cm

3D-Fit[®]
Technology

CN-009
Scale 1/2

Available Sizes:

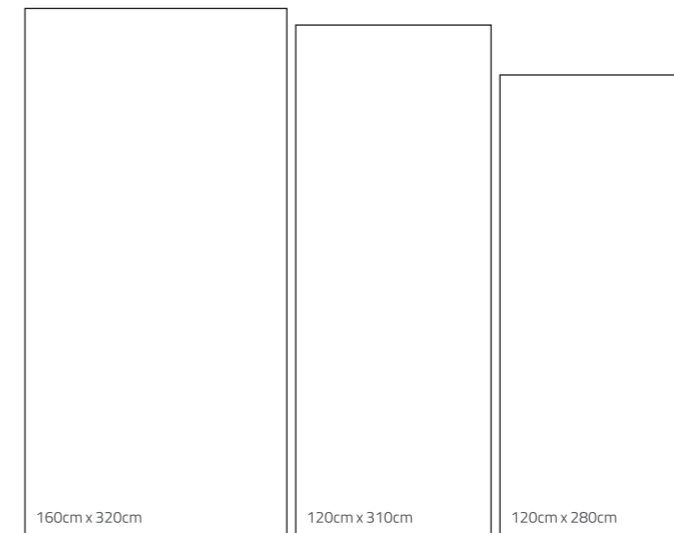

Available Colours



Beige

QR Model Information:



Available Sizes & Finishes:

Normal Size	Matt	Box	Box M2	Box Kg	Pallet Pz	Pallet M2	Pallet Kg	Pallet Dimensions	Trolley Pallet	Trolley M2	Trolley Kg
160x320 - 0.9 cm	●	1	5.12	111	20	102.4	2357	337x177x52 cm	9	921.6	21213
120x310 - 0.9 cm	●	1	3.72	80	28	104.16	2390	327x137x60 cm	9	937.44	21510
120x280 - 0.9 cm	●	1	3.36	73	30	100.8	2322	297x137x62 cm	10	1008	23223.2

FB-005

Fabric



Matt

Porcelain Tile
Rectified
Destonified: V.2
Sizes: 120cm x 310cm

3D-Fit®
Technology

FB-005
Scale 1/2



Matt

Porcelain Tile
Rectified
Destonified: V.2
Sizes: 120cm x 310cm

3D-Fit®
Technology

FB-D-005
Scale 1/2

Available Colours

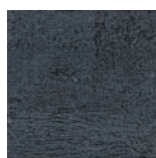

Dark

QR Model Information:



FB-D-005 Faces:



FB-D-005
120cm x 310 cm

Available Sizes:

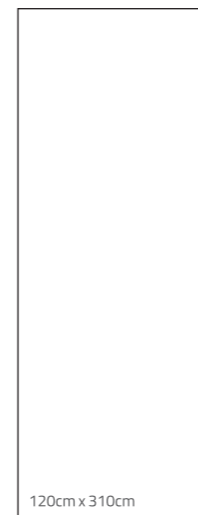

120cm x 310cm

Available Sizes & Finishes:

Normal Size	Matt	Box	Box M2	Box Kg	Pallet Pz	Pallet M2	Pallet Kg	Pallet Dimensions	Trolley Pallet	Trolley M2	Trolley Kg
120x310 - 0.9 cm	●	1	3.72	80	28	104.16	2390	327x137x60 cm	9	937.44	21510

GR-004

Granite

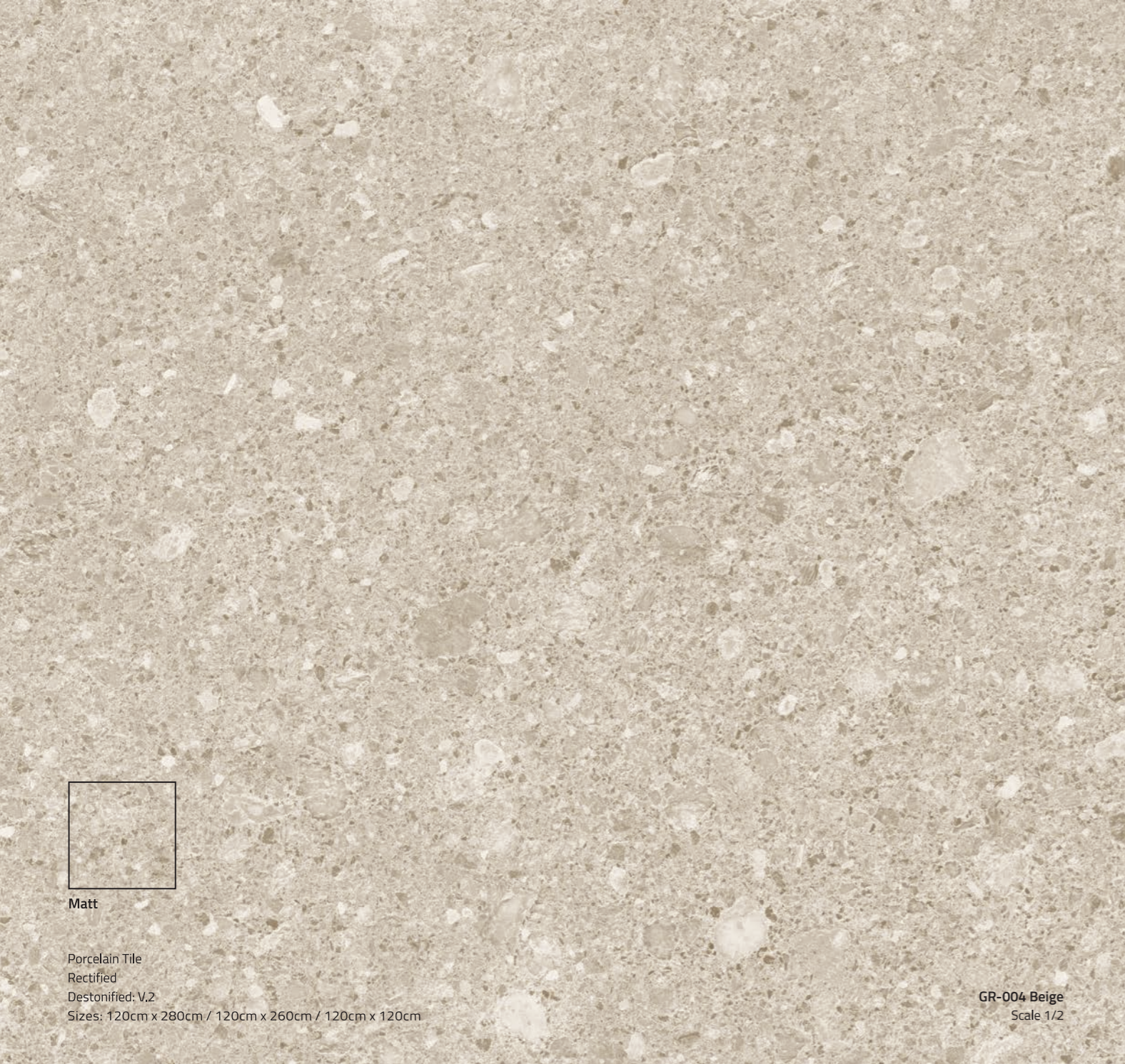

Matt

Porcelain Tile
Rectified
Destonified: V.2
Sizes: 120cm x 280cm / 120cm x 260cm / 120cm x 120cm

GR-004 Beige
Scale 1/2

Available Colours

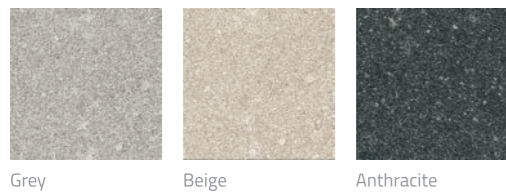

Grey

Beige

Anthracite

QR Model Information:



Available Sizes:

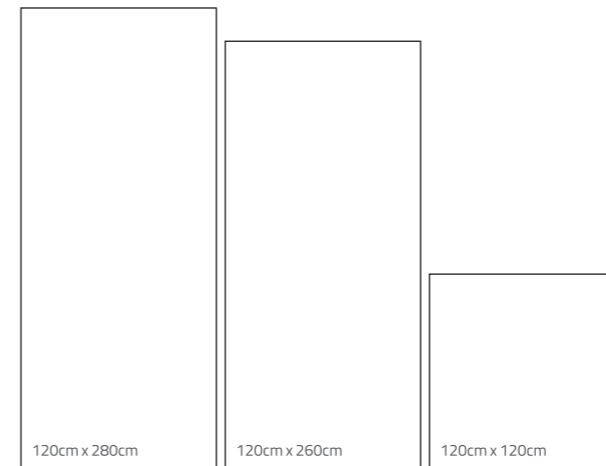

Available Sizes & Finishes:

Normal Size	Matt	Box	Box M2	Box Kg	Pallet Pz	Pallet M2	Pallet Kg	Pallet Dimensions	Trolley Pallet	Trolley M2	Trolley Kg
120x280 - 0,9 cm	●	1	3,36	73	30	100,8	2322	297x137x62 cm	10	1008	23223,2
120x260 - 0,9 cm	●	1	3,12	67,5	33	102,96	2350	277x137x64 cm	10	1029,6	23500
120x120 - 1 cm	●	1	1,44	34	45	64,8	1620	137x137x83 cm	14	907,2	22680

GR-005

Granite

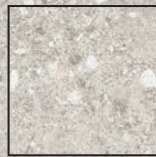
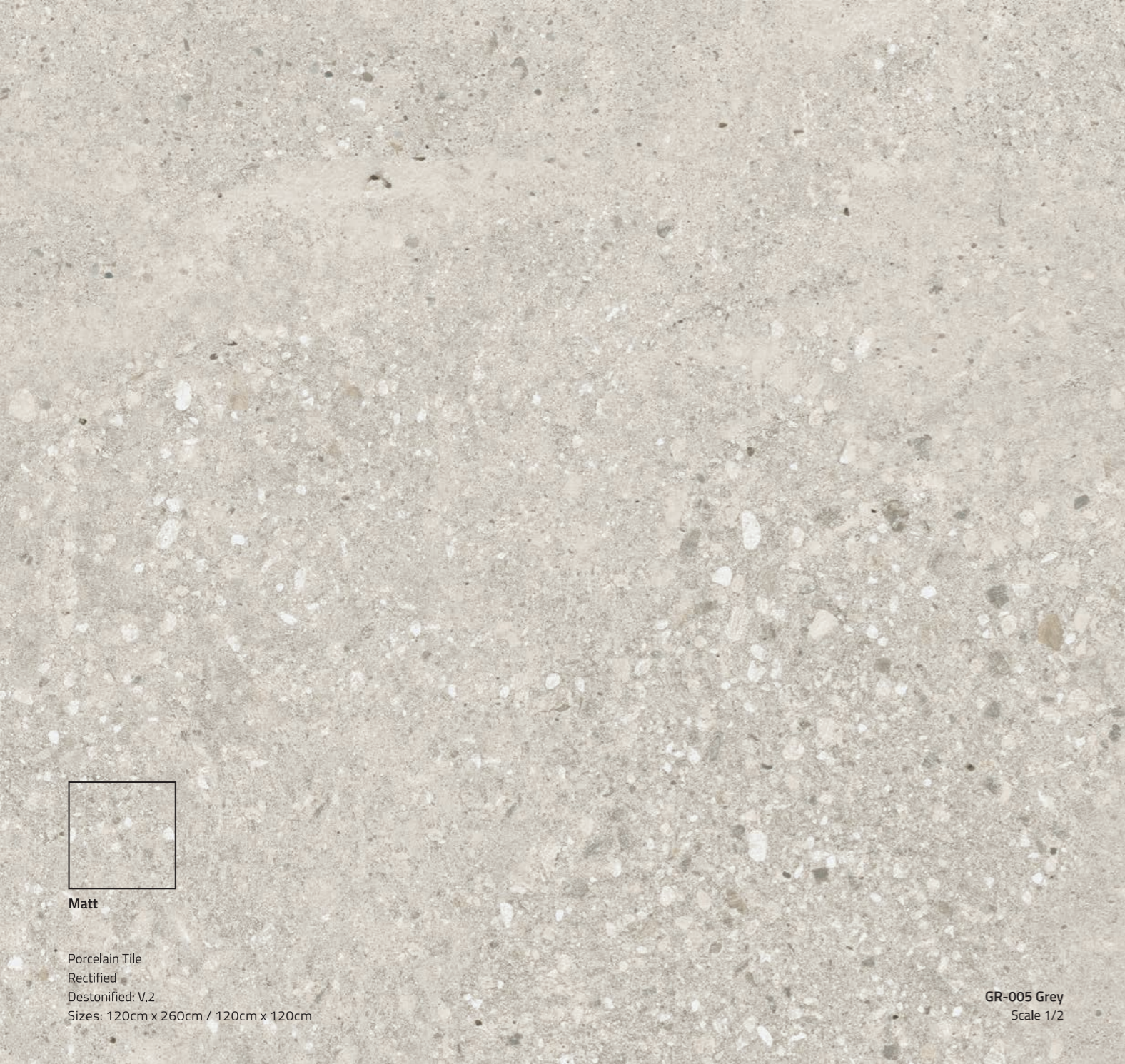

Matt

Porcelain Tile
Rectified
Destonified: V.2
Sizes: 120cm x 260cm / 120cm x 120cm

GR-005 Grey
Scale 1/2

Available Colours



Grey

Graphite

White

Taupe

Beige

QR Model Information:



Available Sizes:

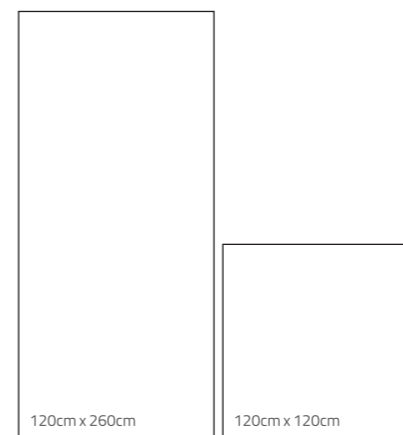

Available Sizes & Finishes:

Normal Size	Matt	Box	Box M2	Box Kg	Pallet Pz	Pallet M2	Pallet Kg	Pallet Dimensions	Trolley Pallet	Trolley M2	Trolley Kg
120x260 - 0.9 cm	●	1	3.12	67.5	33	102.96	2350	277x137x64 cm	10	1029.6	23500
120x120 - 1 cm	●	1	1.44	34	45	64.8	1620	137x137x83 cm	14	907.2	22680

MB-005

Marble



Matt

Porcelain Tile
Rectified
Destonified: V.2
Sizes: 120cm x 260cm

MB-005
Scale 1/2

Available Colours



White

QR Model Information:



Available Sizes:



120cm x 260cm

Available Sizes & Finishes:

Normal Size	Matt	Box	Box M2	Box Kg	Pallet Pz	Pallet M2	Pallet Kg	Pallet Dimensions	Trolley Pallet	Trolley M2	Trolley Kg
120x260 - 0.9 cm	●	1	3.12	67.5	33	102.96	2350	277x137x64 cm	10	1029.6	23500

MB-006

Marble

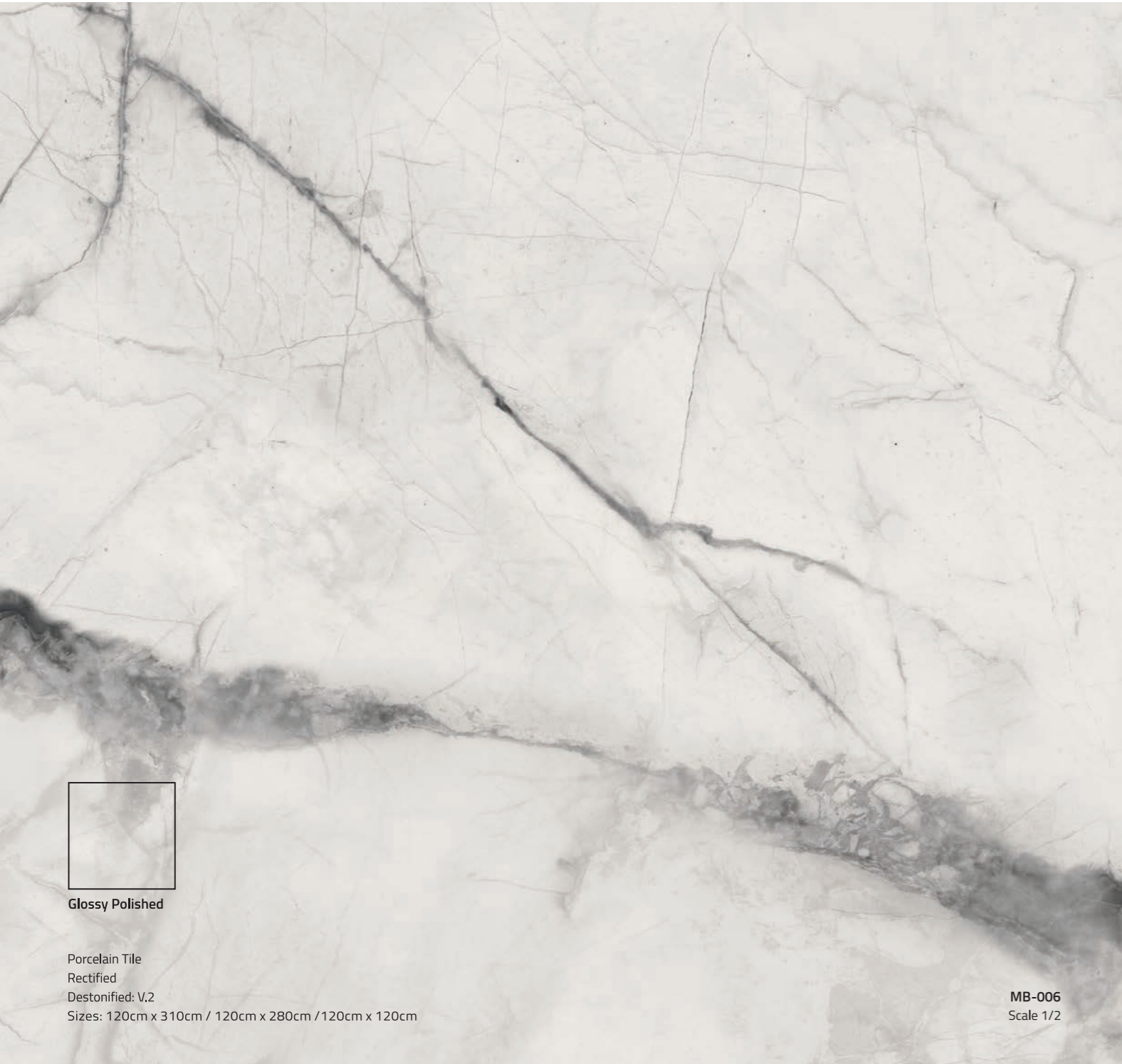

Glossy Polished

Porcelain Tile
Rectified
Destonified: V,2
Sizes: 120cm x 310cm / 120cm x 280cm / 120cm x 120cm

MB-006
Scale 1/2

Available Colours

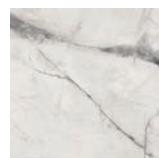

White

QR Model Information:



Available Sizes:

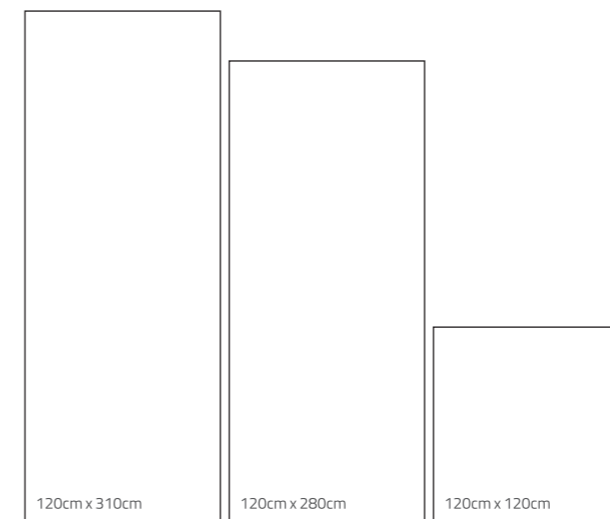

Available Sizes & Finishes:

Normal Size	Glossy Polished	Box	Box M2	Box Kg	Pallet Pz	Pallet M2	Pallet Kg	Pallet Dimensions	Trolley Pallet	Trolley M2	Trolley Kg
120x310 - 0,9 cm	●	1	3,72	80	28	104,16	2390	327x137x60 cm	9	937,44	21510
120x280 - 0,9 cm	●	1	3,36	73	30	100,8	2322	297x137x62 cm	10	1008	23223,2
120x120 - 1 cm	●	1	1,44	34	45	64,8	1620	137x137x83 cm	14	907,2	22680

ME-004

Metal



Matt

Lappato

Porcelain Tile
Rectified
Destonified: V.2
Sizes: 120cm x 260cm

ME-004 Black
Scale 1/2

Available Colours



Black

Silver

QR Model Information:



Available Sizes:

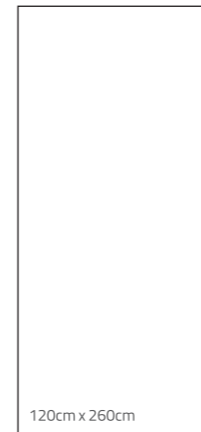

120cm x 260cm

Complements:

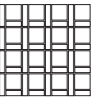

Forma Concept 3
33cm x 33cm

Available Sizes & Finishes:

Normal Size	Lappato	Matt	Box	Box M2	Box Kg	Pallet Pz	Pallet M2	Pallet Kg	Pallet Dimensions	Trolley Pallet	Trolley M2	Trolley Kg
120x260 - 0.9 cm	●	●	1	3.12	67.5	33	102.96	2350	277x137x64 cm	10	1029.6	23500

ME-005

Metal



Lappato

Porcelain Tile
Rectified
Destonified: V.2
Sizes: 120cm x 260cm

ME-005 Beige
Scale 1/2

Available Colours

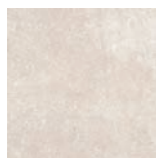

Beige

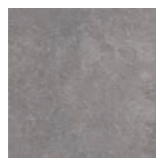

Cobre



Blanco



Acero

QR Model Information:



Available Sizes:



120cm x 260cm

Available Sizes & Finishes:

Normal Size	Lappato	Box	Box M2	Box Kg	Pallet Pz	Pallet M2	Pallet Kg	Pallet Dimensions	Trolley Pallet	Trolley M2	Trolley Kg
120x260 - 0.9 cm	●	1	3.12	67.5	33	102.96	2350	277x137x64 cm	10	1029.6	23500

OX-003

Onyx

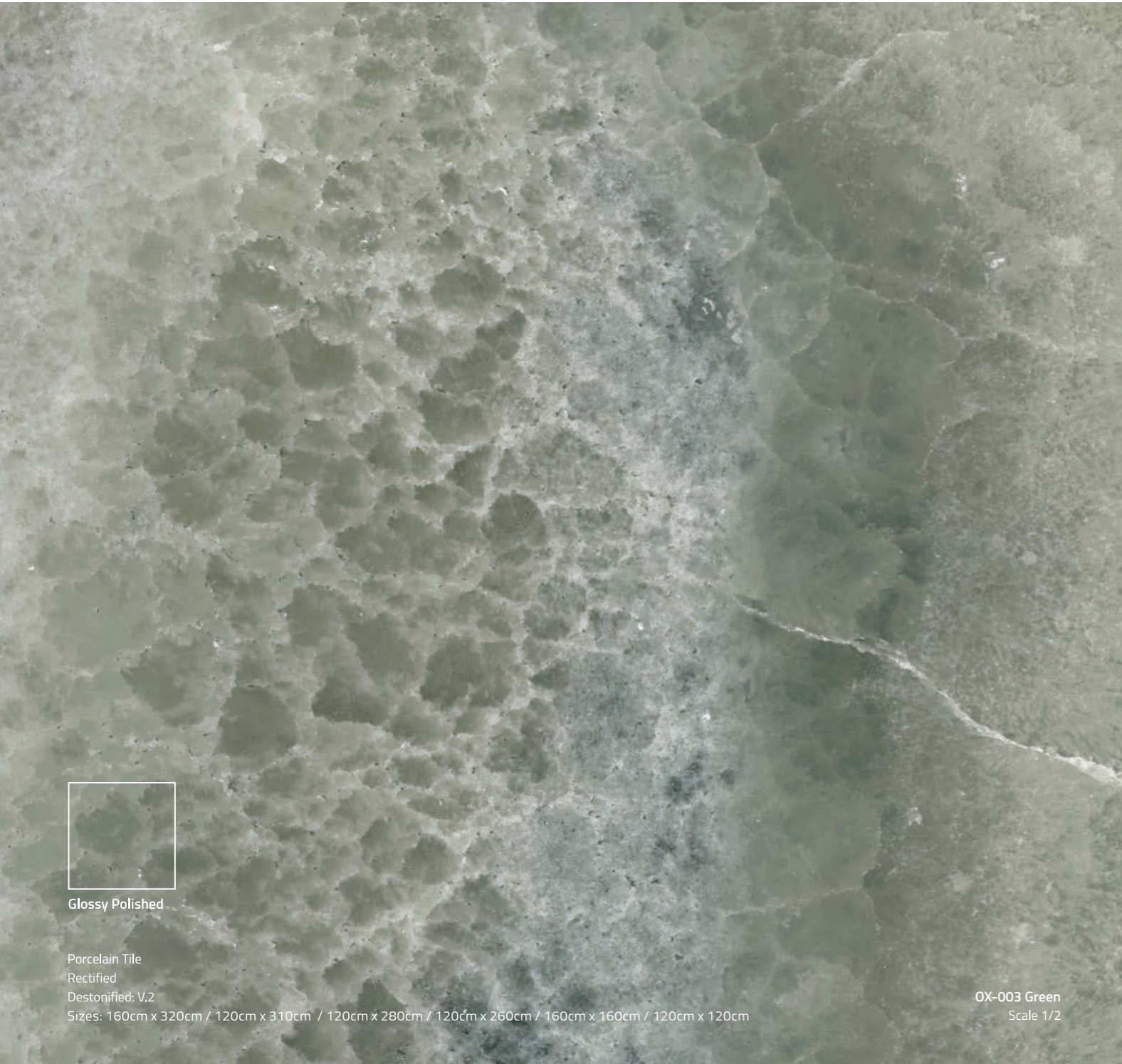

Available Colours

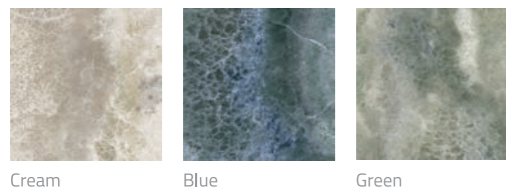

Cream

Blue

Green

* Bookmatch for 160cmx320cm, 120cmx310cm and 120cmx280cm.

QR Model Information:



Bookmatch faces:

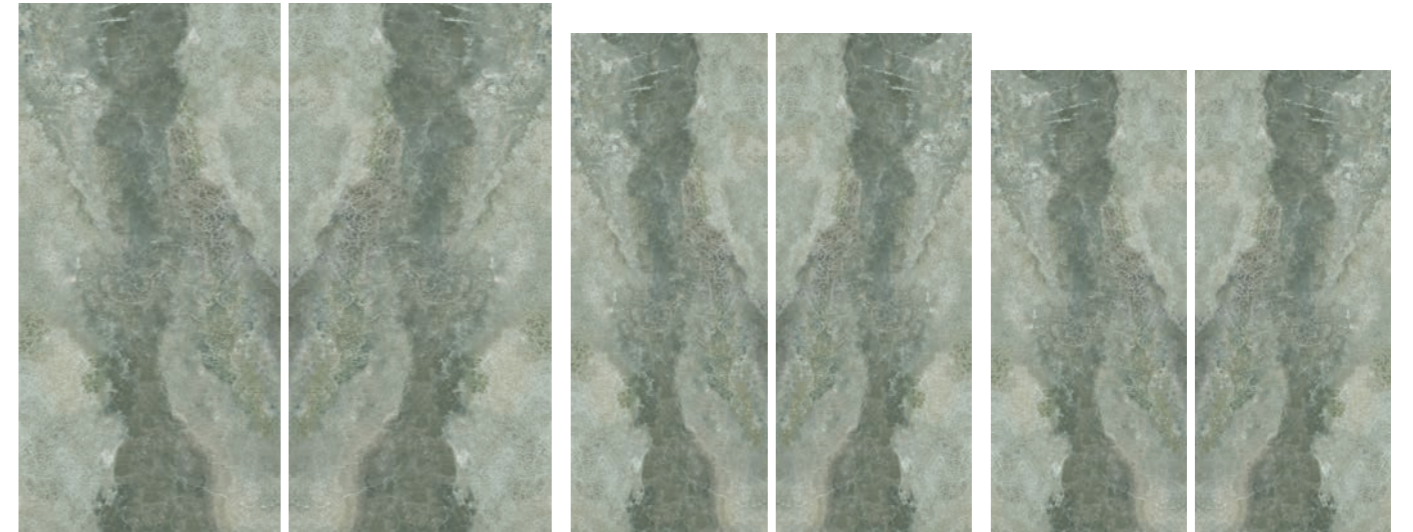

OX-003 Bookmatch
160cm x 320cm

OX-003 Bookmatch
120cm x 310cm

OX-003 Bookmatch
120cm x 280cm

Available Sizes:

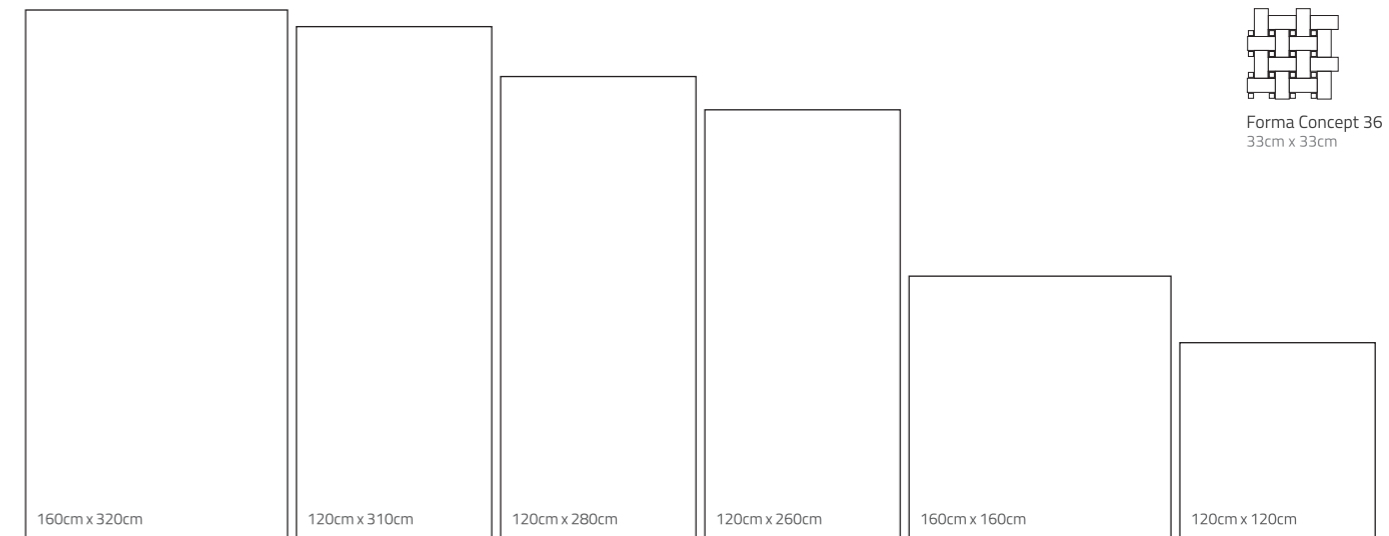

Complements:

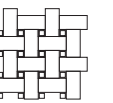

Forma Concept 36
33cm x 33cm

Available Sizes & Finishes:

Normal Size	Glossy Polished	Box	Box M2	Box Kg	Pallet Pz	Pallet M2	Pallet Kg	Pallet Dimensions	Trolley Pallet	Trolley M2	Trolley Kg
160x320 - 0.9 cm	●	1	5.12	111	20	102.4	2357	337x177x52 cm	9	921.6	21213
120x310 - 0.9 cm	●	1	3.72	80	28	104.16	2390	327x137x60 cm	9	937.44	21510
120x280 - 0.9 cm	●	1	3.36	73	30	100.8	2322	297x137x62 cm	10	1008	23223.2
120x260 - 0.9 cm	●	1	3.12	67.5	33	102.96	2350	277x137x64 cm	10	1029.6	23500
160x160 - 1 cm	●	1	2.56	60	35	89.6	2200	177x177x71 cm	10	896	22000
120x120 - 1 cm	●	1	1.44	34	45	64.8	1620	137x137x83 cm	14	907.2	22680

ST-031

Stone



Matt

Porcelain Tile
Rectified
Destonified: V.2
Sizes: 120cm x 260cm / 120cm x 120cm

ST-031 Light
Scale 1/2

Available Colours

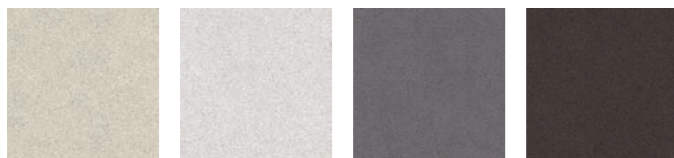

Light

Sand

Grey

Black

* Color Body for Black color.

QR Model Information:



Available Sizes:

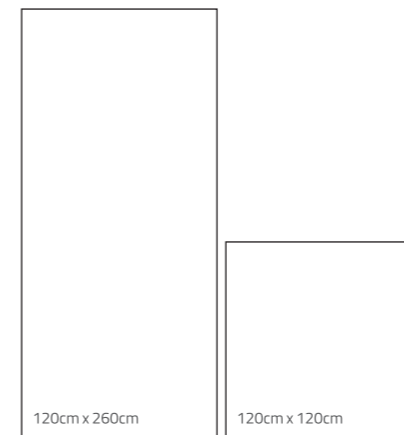

Available Sizes & Finishes:

Normal Size	Matt	Box	Box M2	Box Kg	Pallet Pz	Pallet M2	Pallet Kg	Pallet Dimensions	Trolley Pallet	Trolley M2	Trolley Kg
120x260 - 0,9 cm	●	1	3,12	67,5	33	102,96	2350	277x137x64 cm	10	1029,6	23500
120x120 - 1 cm	●	1	1,44	34	45	64,8	1620	137x137x83 cm	14	907,2	22680

ST-032

Stone



Matt

Porcelain Tile
 Rectified
 Destonified: V,2
 Sizes: 120cm x 310cm / 120cm x 280cm

HEAVY TRAFFIC

ST-032
 Scale 1/2

Available Colours

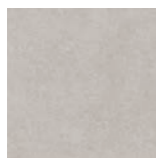

Grey

QR Model Information:



Available Sizes:

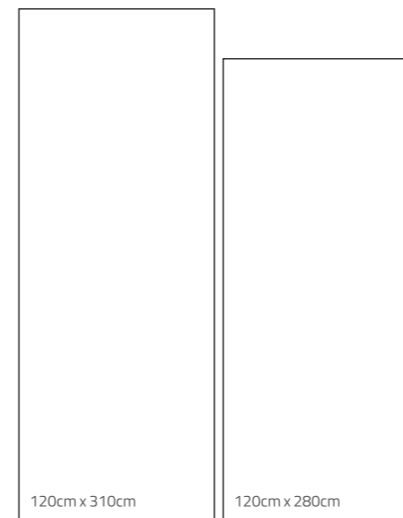

Complements:

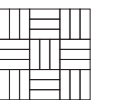

Forma Concept 5
 33cm x 33cm

Available Sizes & Finishes:

Normal Size	Matt	Box	Box M2	Box Kg	Pallet Pz	Pallet M2	Pallet Kg	Pallet Dimensions	Trolley Pallet	Trolley M2	Trolley Kg
120x310 - 0.9 cm	●	1	3.72	80	28	104.16	2390	327x137x60 cm	9	937.44	21510
120x280 - 0.9 cm	●	1	3.36	73	30	100.8	2322	297x137x62 cm	10	1008	23223.2

ST-033

Stone

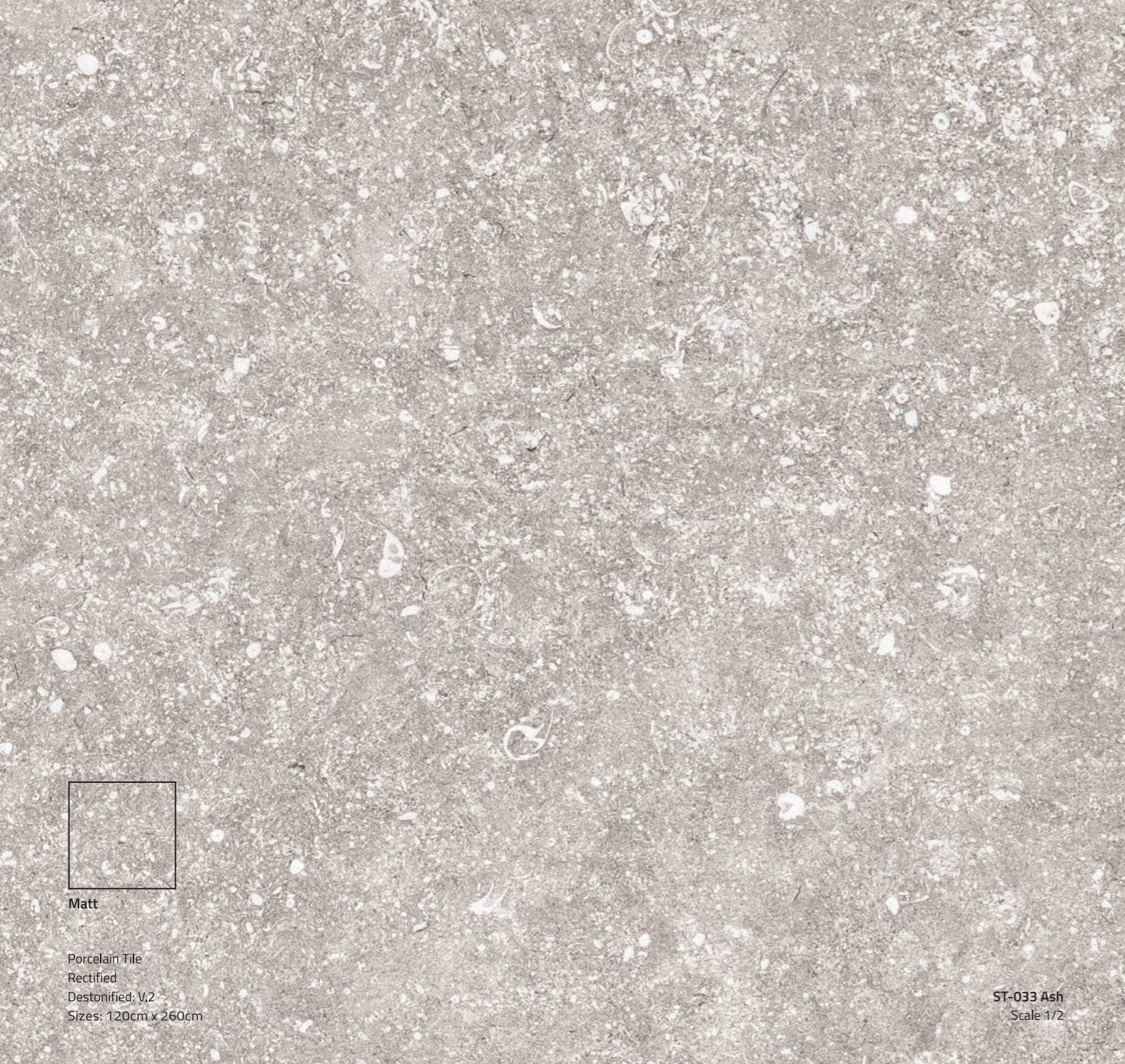

Matt

Porcelain Tile
Rectified
Destonified, V2
Sizes: 120cm x 260cm

ST-033 Ash
Scale 1/2

Available Colours

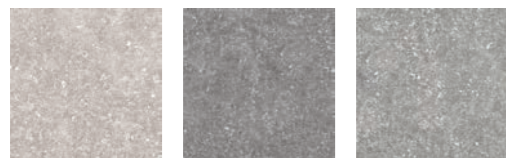

Ash

Anthracite

Grey

QR Model Information:



Available Sizes:



120cm x 260cm

Available Sizes & Finishes:

Normal Size	Matt	Box	Box M2	Box Kg	Pallet Pz	Pallet M2	Pallet Kg	Pallet Dimensions	Trolley Pallet	Trolley M2	Trolley Kg
120x260 - 0.9 cm	●	1	3.12	67.5	33	102.96	2350	277x137x64 cm	10	1029.6	23500

ST-034

Stone

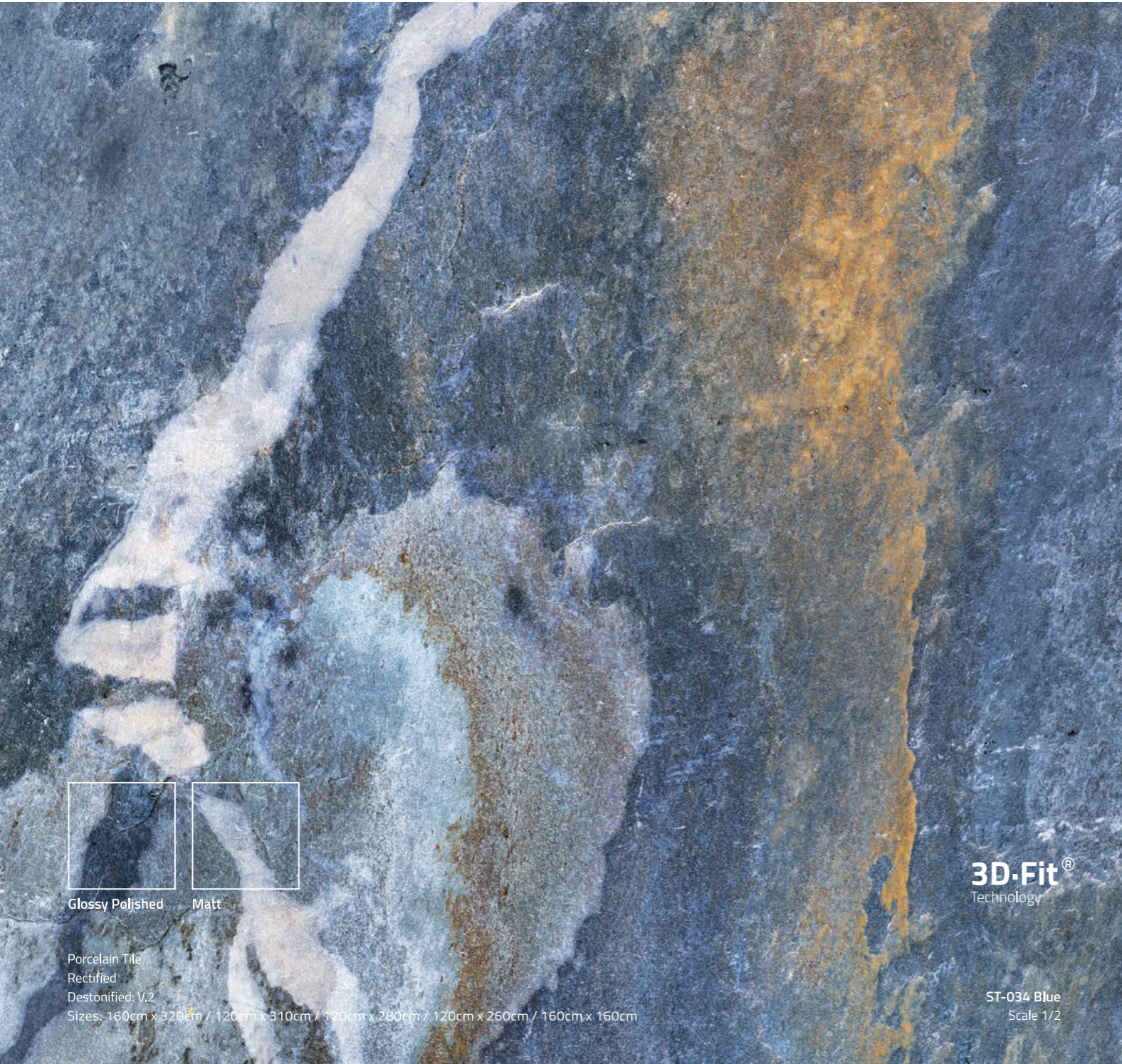

Bookmatch faces:

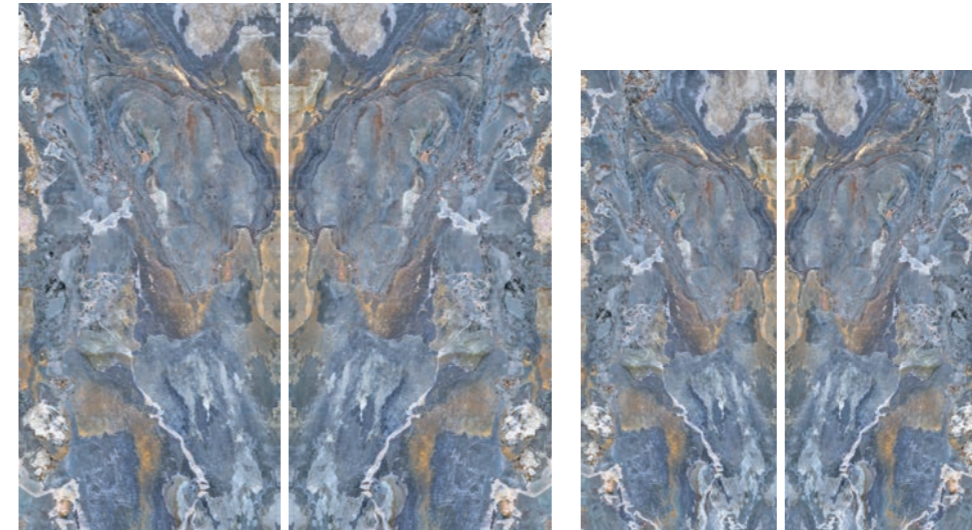

ST-34 Bookmatch
160cm x 320cm

ST-34 Bookmatch
120cm x 280cm

Available Sizes:

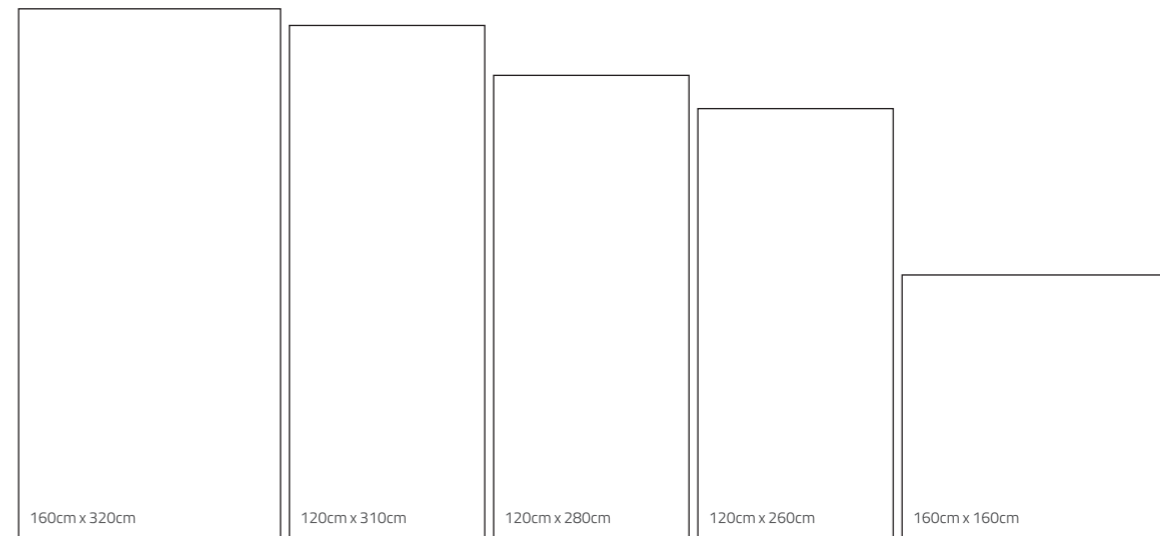

Available Colours

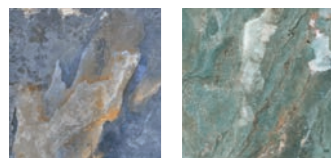

Blue

Green

QR Model Information:



Available Sizes & Finishes:

Normal Size	Glossy Polished	Matt	Box	Box M2	Box Kg	Pallet Pz	Pallet M2	Pallet Kg	Pallet Dimensions	Trolley Pallet	Trolley M2	Trolley Kg
160x320 - 0,9 cm	●	●	1	5.12	111	20	102.4	2357	337x177x52 cm	9	921.6	21213
120x310 - 0,9 cm	●	●	1	3.72	80	28	104.16	2390	327x137x60 cm	9	937.44	21510
120x280 - 0,9 cm	●	●	1	3.36	73	30	100.8	2322	297x137x62 cm	10	1008	23223.2
120x260 - 0,9 cm	●	●	1	3.12	67.5	33	102.96	2350	277x137x64 cm	10	1029.6	23500
160x160 - 1 cm	●	●	1	2.56	60	35	89.6	2200	177x177x71 cm	10	896	22000

* Bookmatch for 160cmx320cm and 120cmx280cm.

ST-035

Stone

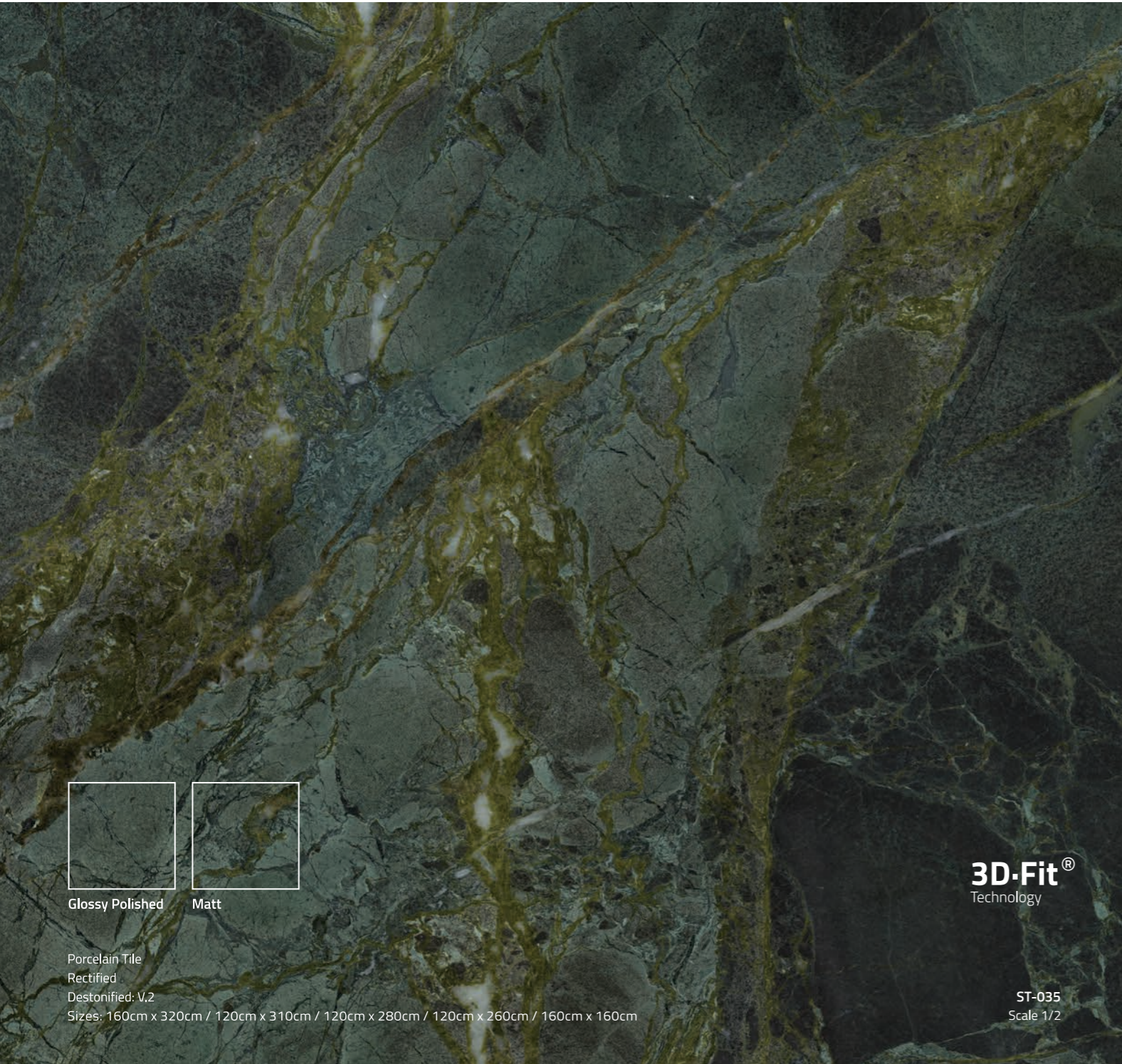

Bookmatch faces:

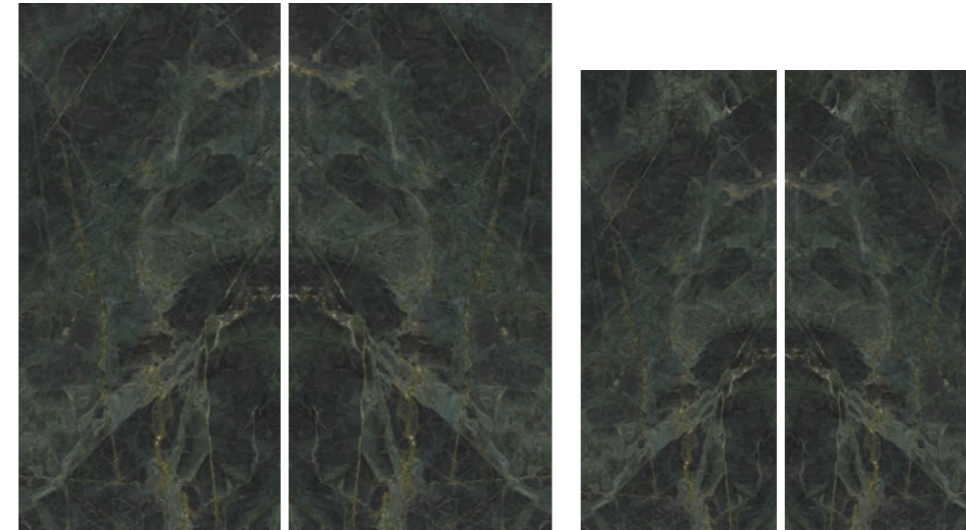

ST-35 Bookmatch
160cm x 320cm

ST-35 Bookmatch
120cm x 280cm

Available Sizes:

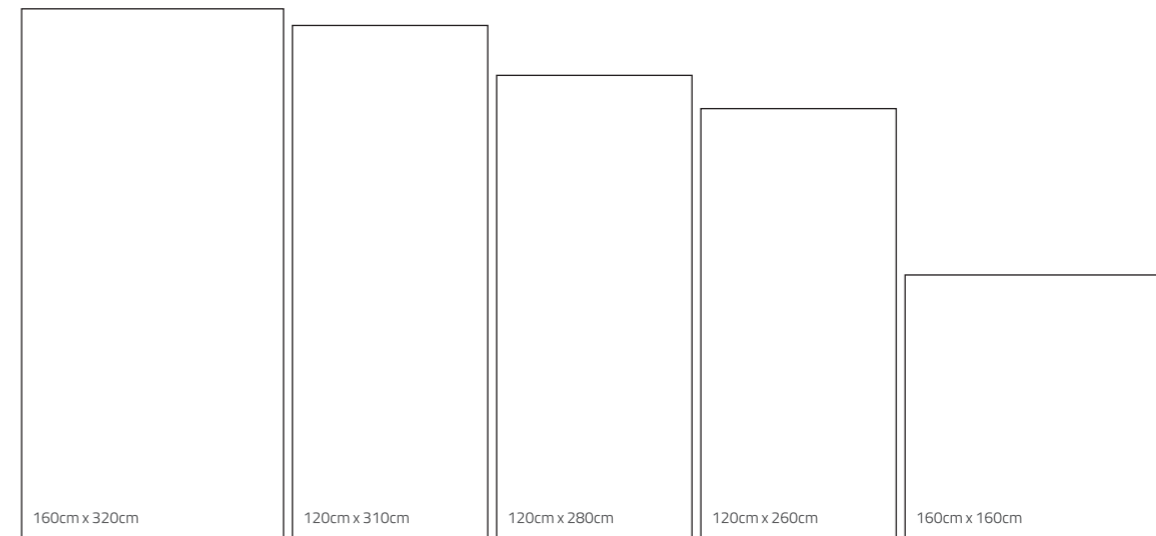

Complements:

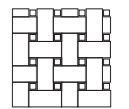

Forma Concept 42
33cm x 33cm

Available Colours

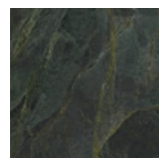

Green

QR Model Information:



Available Sizes & Finishes:

Normal Size	Glossy Polished	Matt	Box	Box M2	Box Kg	Pallet Pz	Pallet M2	Pallet Kg	Pallet Dimensions	Trolley Pallet	Trolley M2	Trolley Kg
160x320 - 0,9 cm	●	●	1	5.12	111	20	102.4	2357	337x177x52 cm	9	921.6	21213
120x310 - 0,9 cm	●	●	1	3.72	80	28	104.16	2390	327x137x60 cm	9	937.44	21510
120x280 - 0,9 cm	●	●	1	3.36	73	30	100.8	2322	297x137x62 cm	10	1008	23223.2
120x260 - 0,9 cm	●	●	1	3.12	67.5	33	102.96	2350	277x137x64 cm	10	1029.6	23500
160x160 - 1 cm	●	●	1	2.56	60	35	89.6	2200	177x177x71 cm	10	896	22000

* Bookmatch for 160cmx320cm and 120cmx280cm.

ST-036

Stone

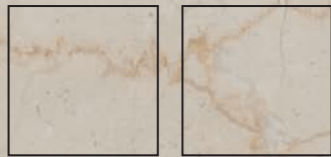

Glossy Polished Matt

3D-Fit®
Technology

Porcelain Tile
Rectified
Destonified: V,2
Sizes: 160cm x 320cm / 120cm x 310cm / 120cm x 280cm / 120cm x 260cm / 160cm x 160cm / 120cm x 120cm

ST-036 Beige
Scale 1/2

Available Colours



Beige White

QR Model Information:



Available Sizes:

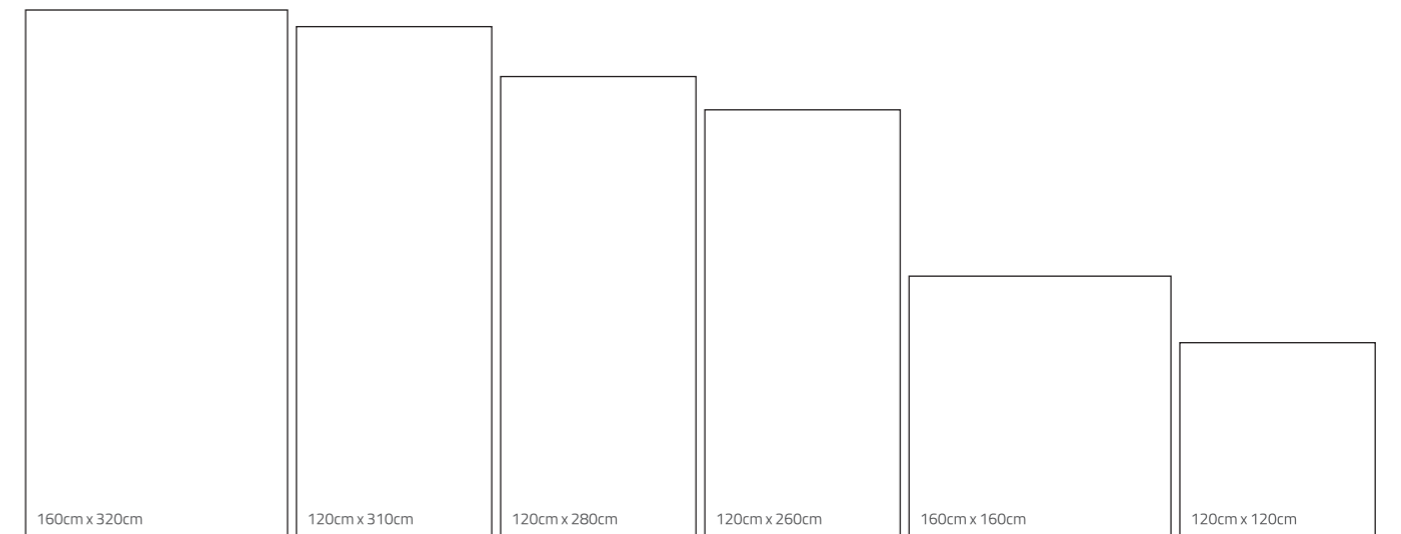

Available Sizes & Finishes:

Normal Size	Glossy Polished	Matt	Box	Box M2	Box Kg	Pallet Pz	Pallet M2	Pallet Kg	Pallet Dimensions	Trolley Pallet	Trolley M2	Trolley Kg
160x320 - 0.9 cm	●	●	1	5.12	111	20	102.4	2357	337x177x52 cm	9	921.6	21213
120x310 - 0.9 cm	●	●	1	3.72	80	28	104.16	2390	327x137x60 cm	9	937.44	21510
120x280 - 0.9 cm	●	●	1	3.36	73	30	100.8	2322	297x137x62 cm	10	1008	23223.2
120x260 - 0.9 cm	●	●	1	3.12	67.5	33	102.96	2350	277x137x64 cm	10	1029.6	23500
160x160 - 1 cm	●	●	1	2.56	60	35	89.6	2200	177x177x71 cm	10	896	22000
120x120 - 1 cm	●	●	1	1.44	34	45	64.8	1620	137x137x83 cm	14	907.2	22680

ST-037

Stone

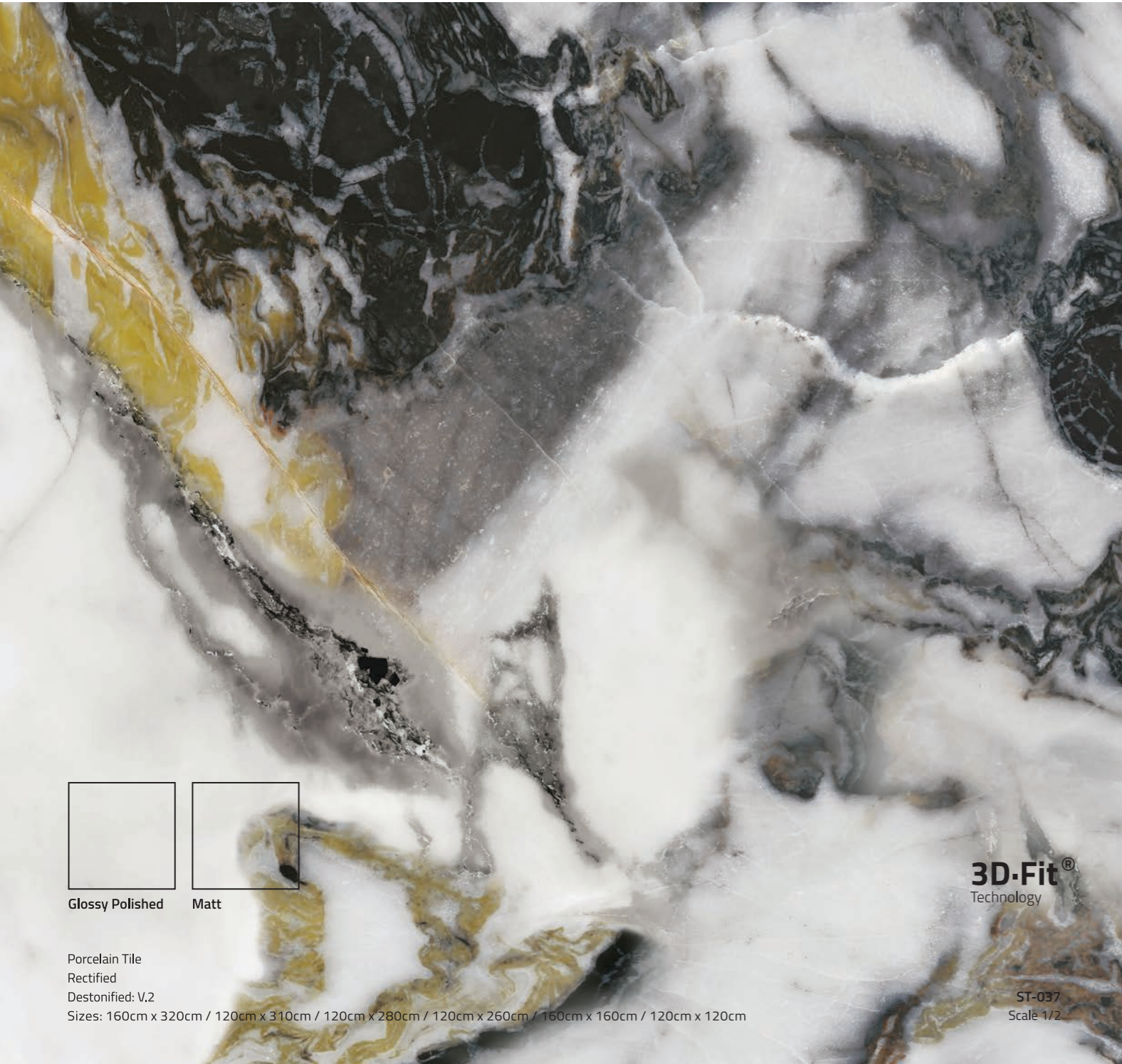

Glossy Polished Matt

Porcelain Tile
Rectified
Destonified: V.2
Sizes: 160cm x 320cm / 120cm x 310cm / 120cm x 280cm / 120cm x 260cm / 160cm x 160cm / 120cm x 120cm

3D-Fit[®]
Technology

ST-037
Scale 1/2

Available Colours



White

QR Model Information:



* Bookmatch for 160cmx320cm and 120cmx280cm.

Bookmatch faces:

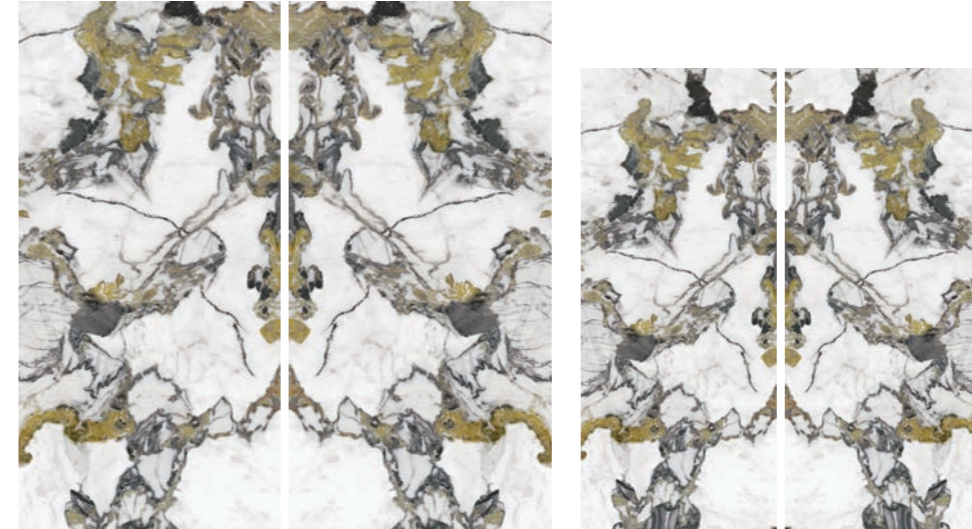

ST-037 Bookmatch
160cm x 320cm

ST-037 Bookmatch
120cm x 280cm

Available Sizes:

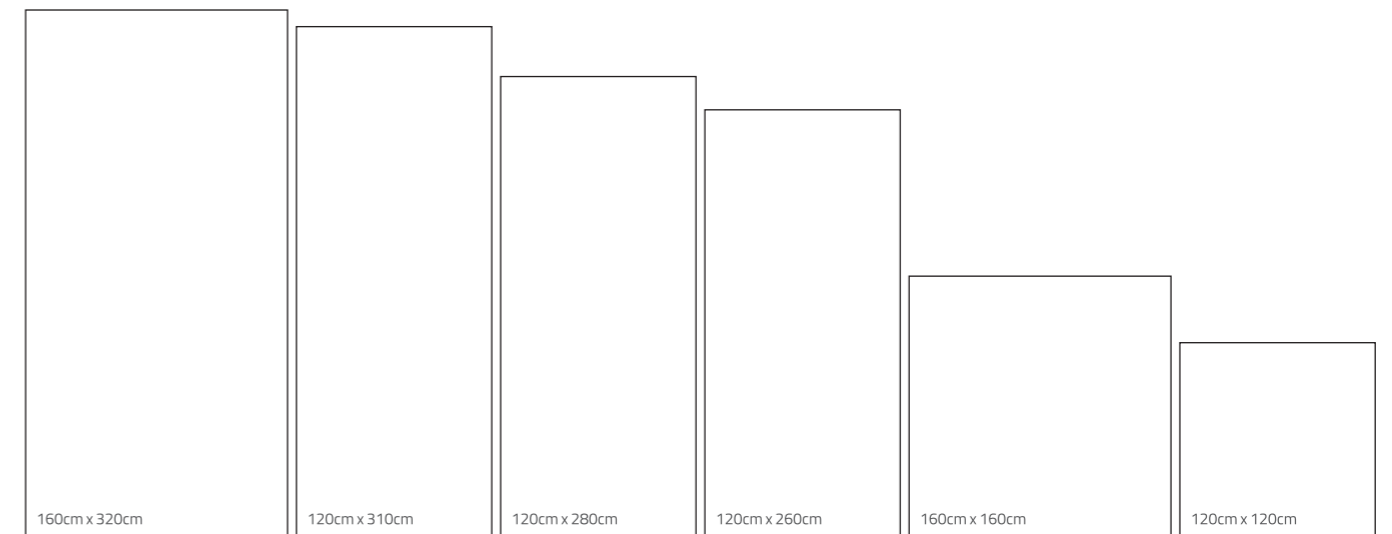

Available Sizes & Finishes:

Normal Size	Glossy Polished	Matt	Box	Box M2	Box Kg	Pallet Pz	Pallet M2	Pallet Kg	Pallet Dimensions	Trolley Pallet	Trolley M2	Trolley Kg
160x320 - 0.9 cm	●	●	1	5.12	111	20	102.4	2357	337x177x52 cm	9	921.6	21213
120x310 - 0.9 cm	●	●	1	3.72	80	28	104.16	2390	327x137x60 cm	9	937.44	21510
120x280 - 0.9 cm	●	●	1	3.36	73	30	100.8	2322	297x137x62 cm	10	1008	23223.2
120x260 - 0.9 cm	●	●	1	3.12	67.5	33	102.96	2350	277x137x64 cm	10	1029.6	23500
160x160 - 1 cm	●	●	1	2.56	60	35	89.6	2200	177x177x71 cm	10	896	22000
120x120 - 1 cm	●	●	1	1.44	34	45	64.8	1620	137x137x83 cm	14	907.2	22680

ST-038

Stone

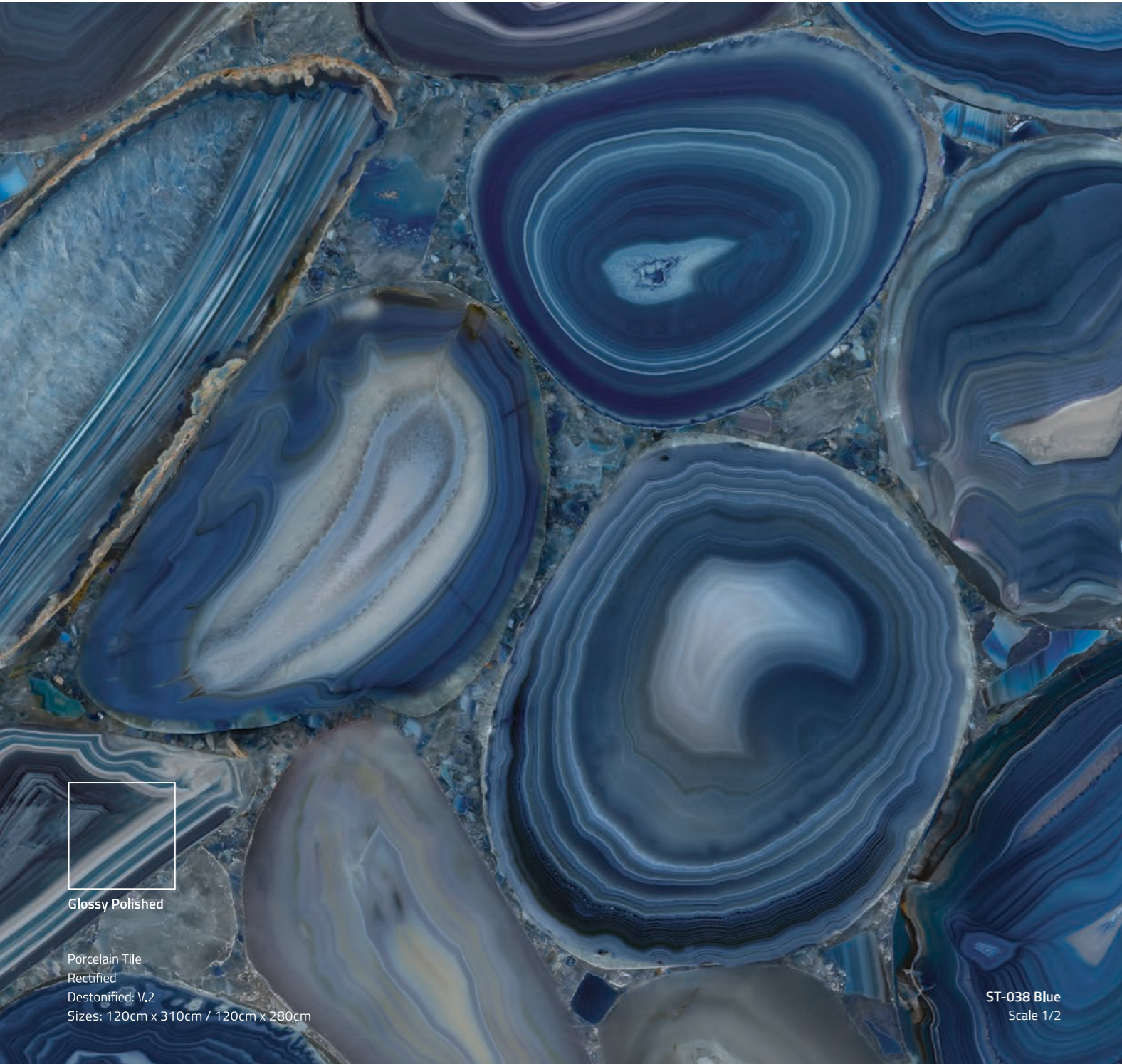

Glossy Polished

Porcelain Tile
Rectified
Destonified: V.2
Sizes: 120cm x 310cm / 120cm x 280cm

ST-038 Blue
Scale 1/2

Available Colours

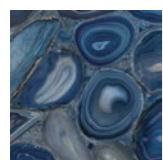

Blue

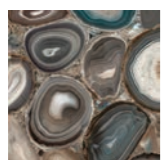

Beige



Grey

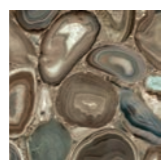

Turquoise

QR Model Information:



Available Sizes:

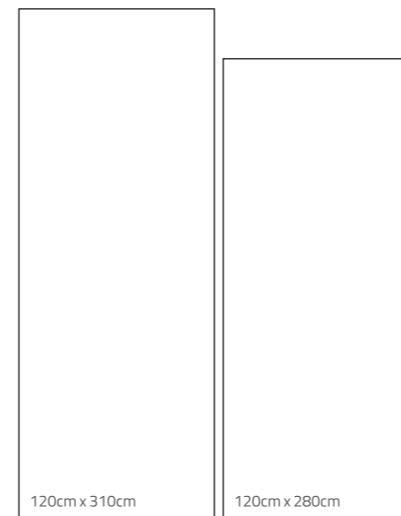

Available Sizes & Finishes:

Normal Size	Glossy Polished	Box	Box M2	Box Kg	Pallet Pz	Pallet M2	Pallet Kg	Pallet Dimensions	Trolley Pallet	Trolley M2	Trolley Kg
120x310 - 0.9 cm	●	1	3.72	80	28	104.16	2390	327x137x60 cm	9	937.44	21510
120x280 - 0.9 cm	●	1	3.36	73	30	100.8	2322	297x137x62 cm	10	1008	23223.2

ST-039

Stone

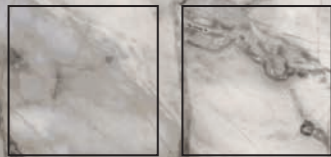

Glossy Polished Matt

Porcelain Tile
Rectified
Destonified: V.2
Sizes: 160cm x 320cm / 120cm x 310cm / 120cm x 280cm

3D-Fit®
Technology

ST-039
Scale 1/2

Available Colours

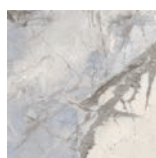

Blue

* Bookmatch for 160cmx320cm and 120cmx280cm.

QR Model Information:



Bookmatch faces:

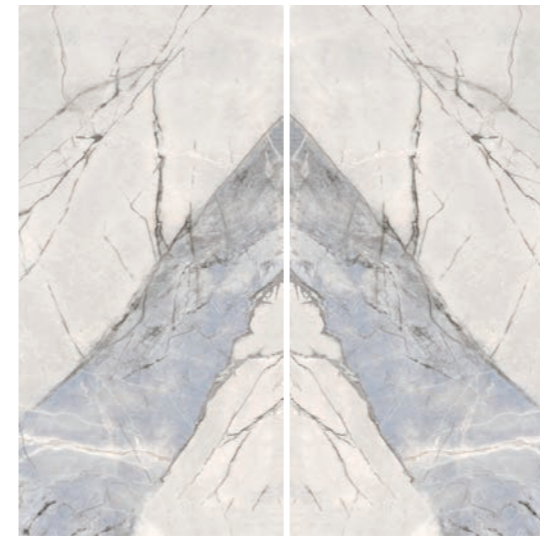

ST-039 Bookmatch
160cm x 320cm

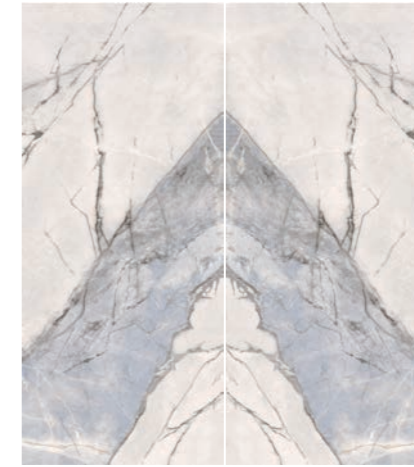

ST-039 Bookmatch
120cm x 280cm

Available Sizes:

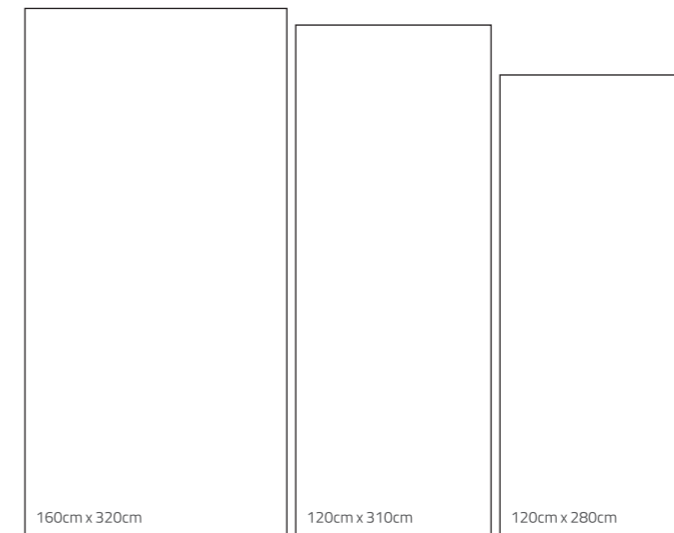

Available Sizes & Finishes:

Normal Size	Glossy Polished	Matt	Box	Box M2	Box Kg	Pallet Pz	Pallet M2	Pallet Kg	Pallet Dimensions	Trolley Pallet	Trolley M2	Trolley Kg
160x320 - 0,9 cm	●	●	1	5,12	111	20	102,4	2357	337x177x52 cm	9	921,6	21213
120x310 - 0,9 cm	●	●	1	3,72	80	28	104,16	2390	327x137x60 cm	9	937,44	21510
120x280 - 0,9 cm	●	●	1	3,36	73	30	100,8	2322	297x137x62 cm	10	1008	23223,2

ST-040

Stone

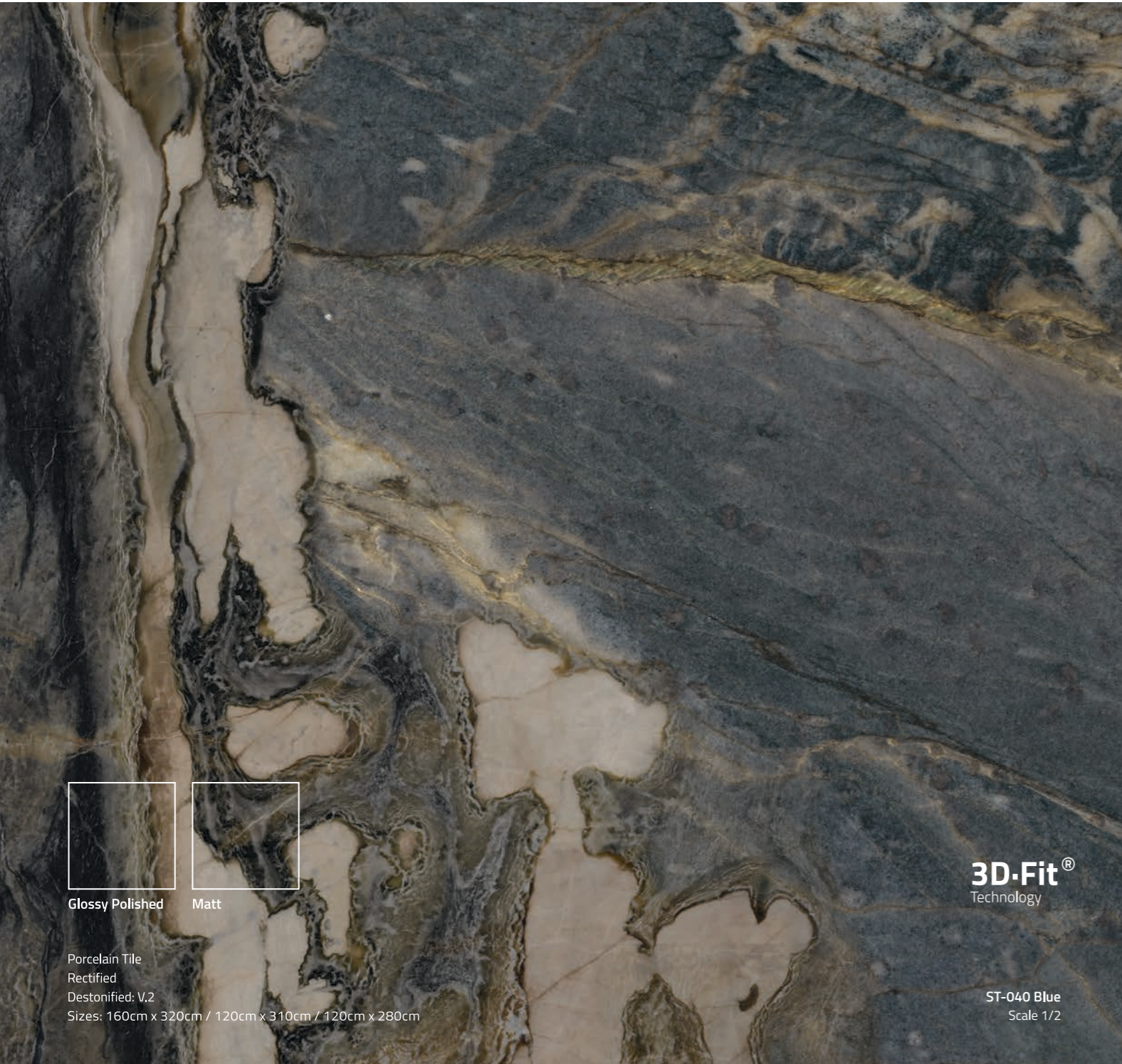

Bookmatch faces:

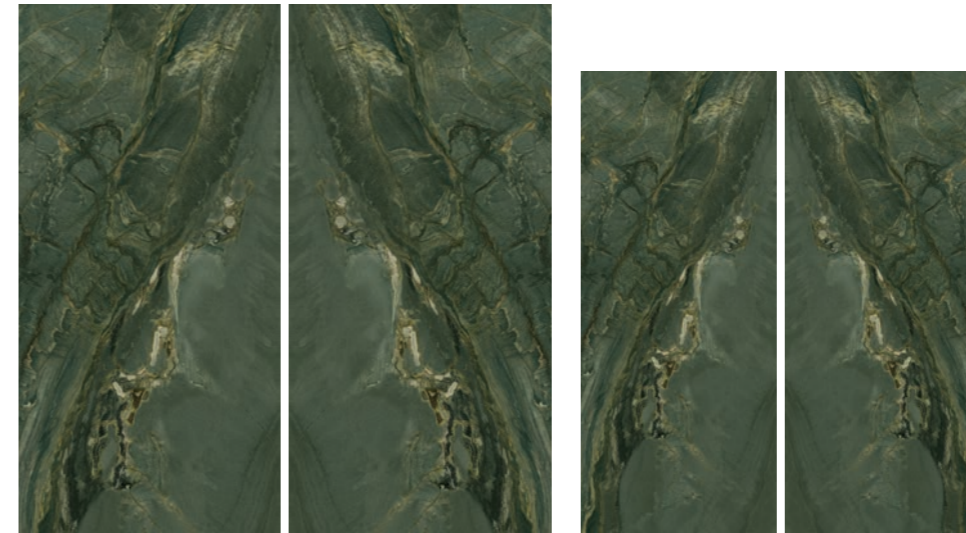

ST-040 Bookmatch
160cm x 320cm

ST-040 Bookmatch
120cm x 280cm

Available Sizes:

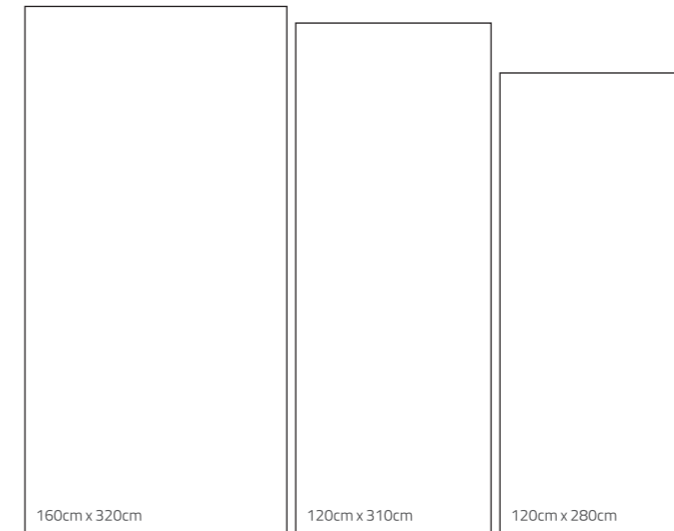

Available Colours

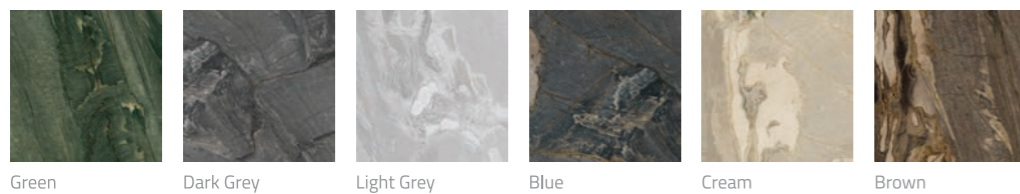

QR Model Information:



Available Sizes & Finishes:

Normal Size	Glossy Polished	Matt	Box	Box M2	Box Kg	Pallet Pz	Pallet M2	Pallet Kg	Pallet Dimensions	Trolley Pallet	Trolley M2	Trolley Kg
160x320 - 0,9 cm	●	●	1	5,12	111	20	102,4	2357	337x177x52 cm	9	921,6	21213
120x310 - 0,9 cm	●	●	1	3,72	80	28	104,16	2390	327x137x60 cm	9	937,44	21510
120x280 - 0,9 cm	●	●	1	3,36	73	30	100,8	2322	297x137x62 cm	10	1008	23223,2

ST-041

Stone



Matt

Porcelain Tile
Rectified
Destonified: V,2
Sizes: 120cm x 260cm / 120cm x 120cm

3D-Fit®
Technology

ST-041 White
Scale 1/2

Available Colours

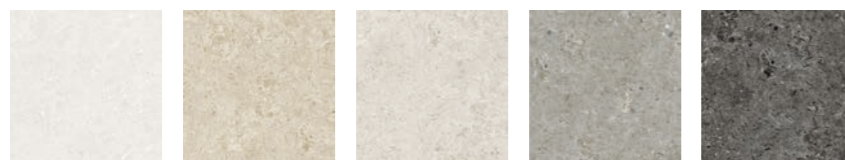

White Beige Light Grey Dark Grey Black

* Color Body for Black color.

QR Model Information:



Available Sizes:

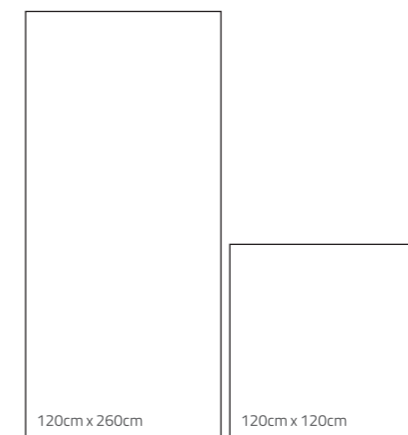

Available Sizes & Finishes:

Normal Size	Matt	Box	Box M2	Box Kg	Pallet Pz	Pallet M2	Pallet Kg	Pallet Dimensions	Trolley Pallet	Trolley M2	Trolley Kg
120x260 - 0.9 cm	●	1	3.12	67.5	33	102.96	2350	277x137x64 cm	10	1029.6	23500
120x120 - 1 cm	●	1	1.44	34	45	64.8	1620	137x137x83 cm	14	907.2	22680

ST-042

Stone

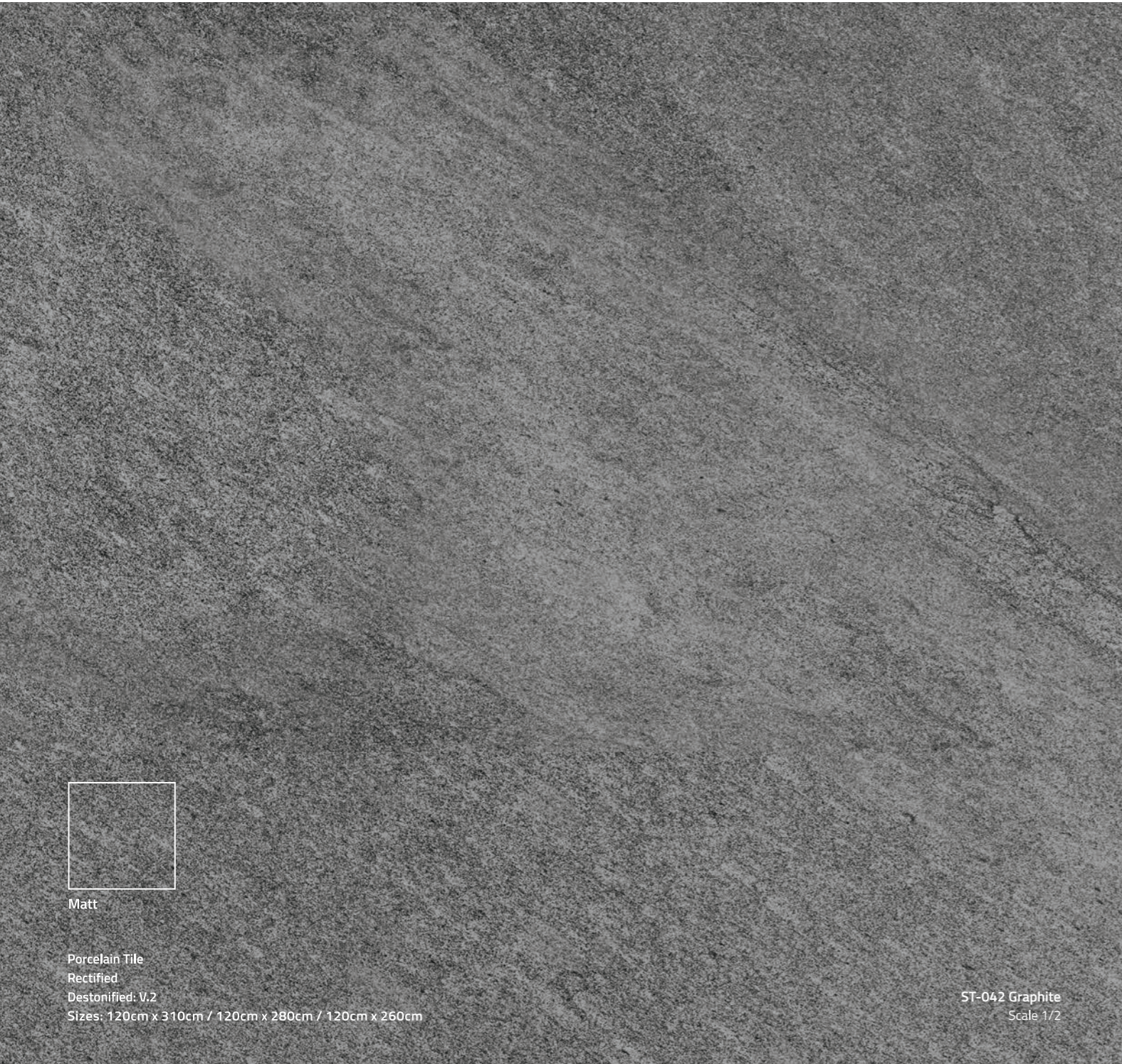

Matt

Porcelain Tile
Rectified
Destonified: V.2
Sizes: 120cm x 310cm / 120cm x 280cm / 120cm x 260cm

ST-042 Graphite
Scale 1/2

Available Colours

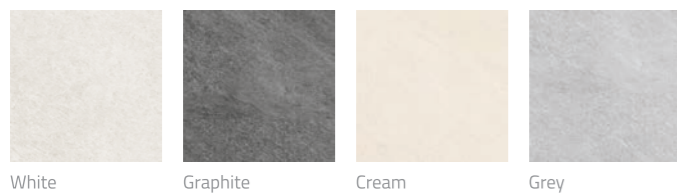

White

Graphite

Cream

Grey

QR Model Information:



Available Sizes:

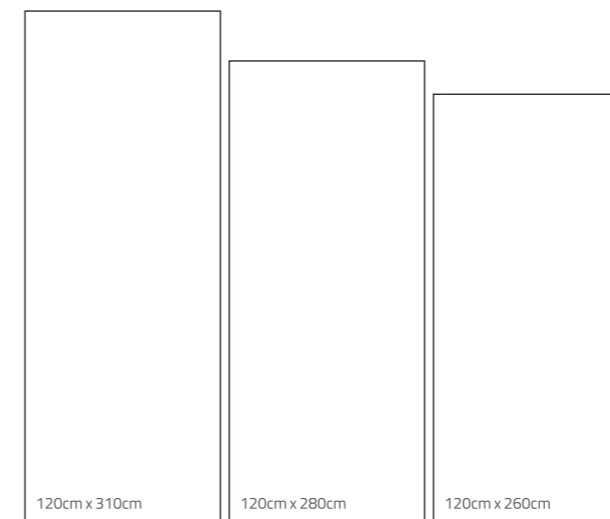

Available Sizes & Finishes:

Normal Size	Matt	Box	Box M2	Box Kg	Pallet Pz	Pallet M2	Pallet Kg	Pallet Dimensions	Trolley Pallet	Trolley M2	Trolley Kg
120x310 - 0.9 cm	●	1	3.72	80	28	104.16	2390	327x137x60 cm	9	937.44	21510
120x280 - 0.9 cm	●	1	3.36	73	30	100.8	2322	297x137x62 cm	10	1008	23223.2
120x260 - 0.9 cm	●	1	3.12	67.5	33	102.96	2350	277x137x64 cm	10	1029.6	23500

ST-043

Stone



Matt

Porcelain Tile
Rectified
Destonified: V.2
Sizes: 120cm x 310cm / 120cm x 280cm / 120cm x 260cm

3D-Fit®
Technology

ST-043 Bone
Scale 1/2

Available Sizes:

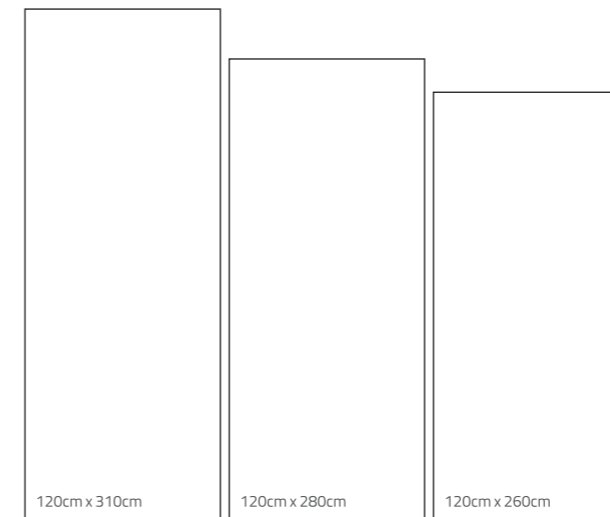

Available Colours

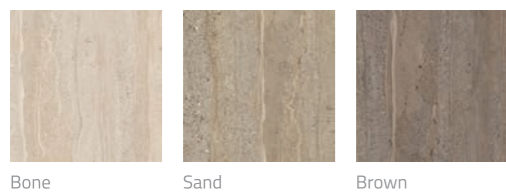

Bone

Sand

Brown

QR Model Information:



Available Sizes & Finishes:

Normal Size	Matt	Box	Box M2	Box Kg	Pallet Pz	Pallet M2	Pallet Kg	Pallet Dimensions	Trolley Pallet	Trolley M2	Trolley Kg
120x310 - 0,9 cm	●	1	3,72	80	28	104,16	2390	327x137x60 cm	9	937,44	21510
120x280 - 0,9 cm	●	1	3,36	73	30	100,8	2322	297x137x62 cm	10	1008	23223,2
120x260 - 0,9 cm	●	1	3,12	67,5	33	102,96	2350	277x137x64 cm	10	1029,6	23500

ST-044

Stone

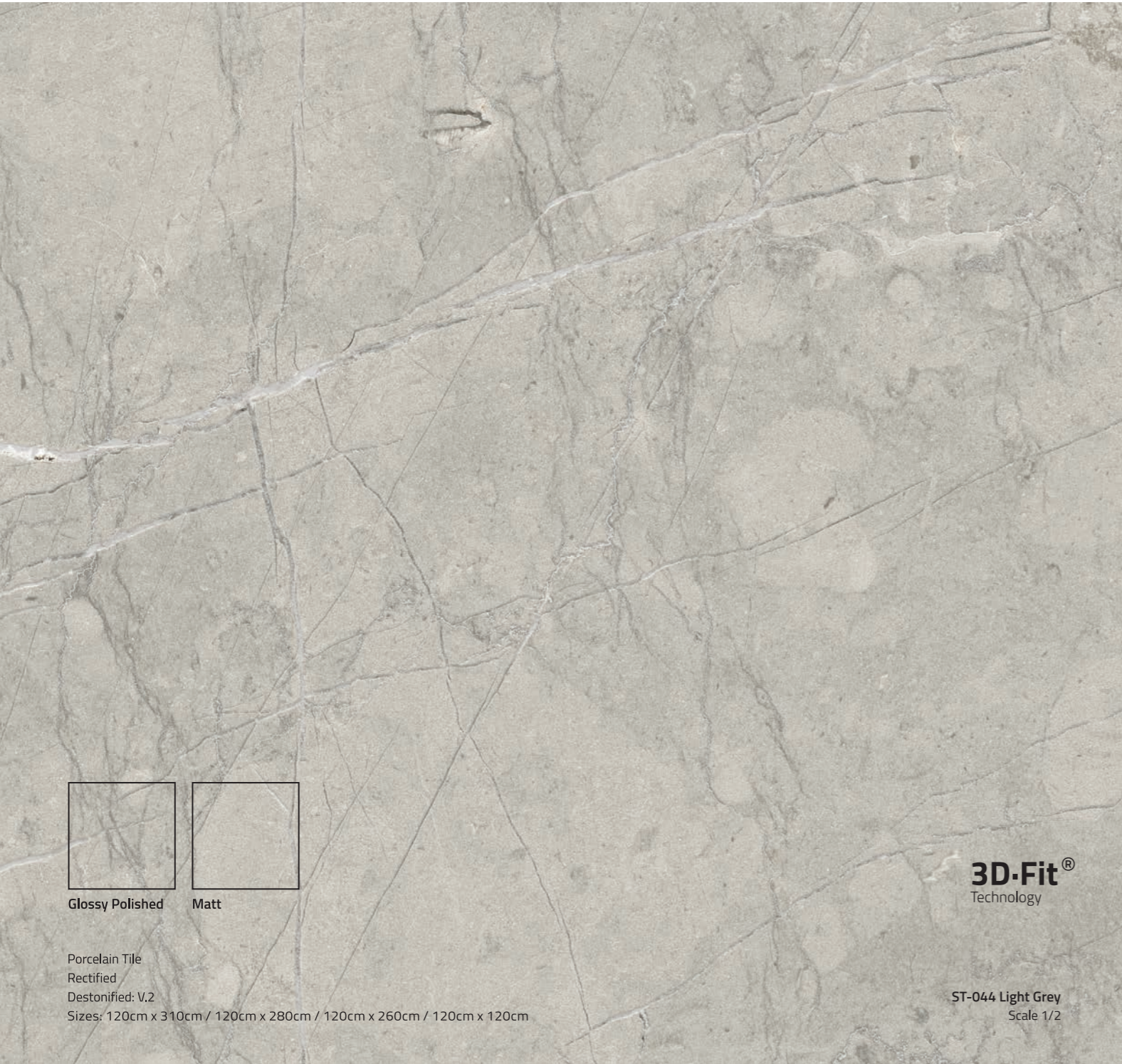

Available Sizes:

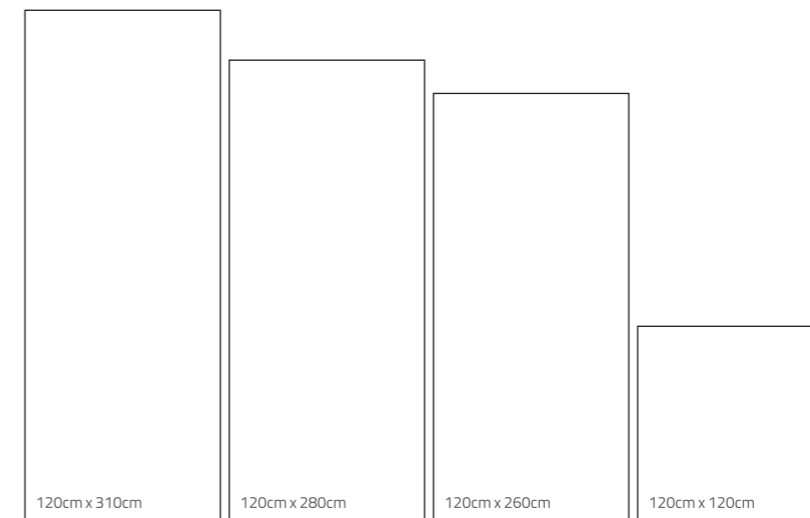

Available Colours

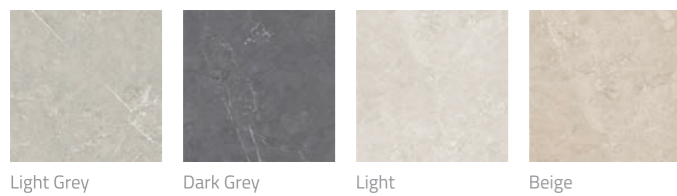

QR Model Information:



Available Sizes & Finishes:

Normal Size	Glossy Polished	Matt	Box	Box M2	Box Kg	Pallet Pz	Pallet M2	Pallet Kg	Pallet Dimensions	Trolley Pallet	Trolley M2	Trolley Kg
120x310 - 0.9 cm	●	●	1	3.72	80	28	104.16	2390	327x137x60 cm	9	937.44	21510
120x280 - 0.9 cm	●	●	1	3.36	73	30	100.8	2322	297x137x62 cm	10	1008	23223.2
120x260 - 0.9 cm	●	●	1	3.12	67.5	33	102.96	2350	277x137x64 cm	10	1029.6	23500
120x120 - 1 cm	●	●	1	1.44	34	45	64.8	1620	137x137x83 cm	14	907.2	22680

ST-045

Stone



Porcelain Tile
Rectified
Destonified: V,2
Sizes: 160cm x 320cm / 120cm x 310cm / 120cm x 280cm / 120cm x 260cm

3D-Fit®
Technology

ST-045
Scale 1/2

Available Sizes:

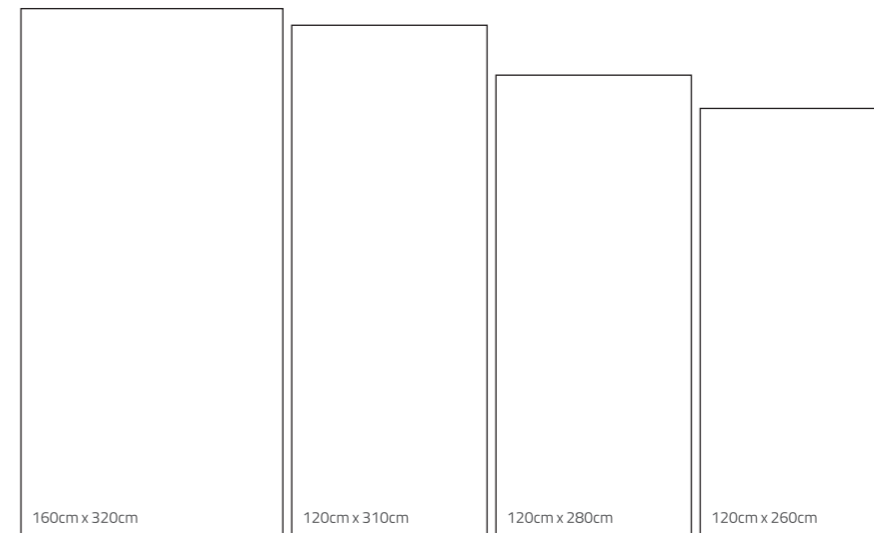

Available Colours



Light

QR Model Information:



Available Sizes & Finishes:

Normal Size	Glossy Polished	Matt	Box	Box M2	Box Kg	Pallet Pz	Pallet M2	Pallet Kg	Pallet Dimensions	Trolley Pallet	Trolley M2	Trolley Kg
160x320 - 0,9 cm	●	●	1	5,12	111	20	102,4	2357	337x177x52 cm	9	921,6	21213
120x310 - 0,9 cm	●	●	1	3,72	80	28	104,16	2390	327x137x60 cm	9	937,44	21510
120x280 - 0,9 cm	●	●	1	3,36	73	30	100,8	2322	297x137x62 cm	10	1008	23223,2
120x260 - 0,9 cm	●	●	1	3,12	67,5	33	102,96	2350	277x137x64 cm	10	1029,6	23500

ST-046

Stone

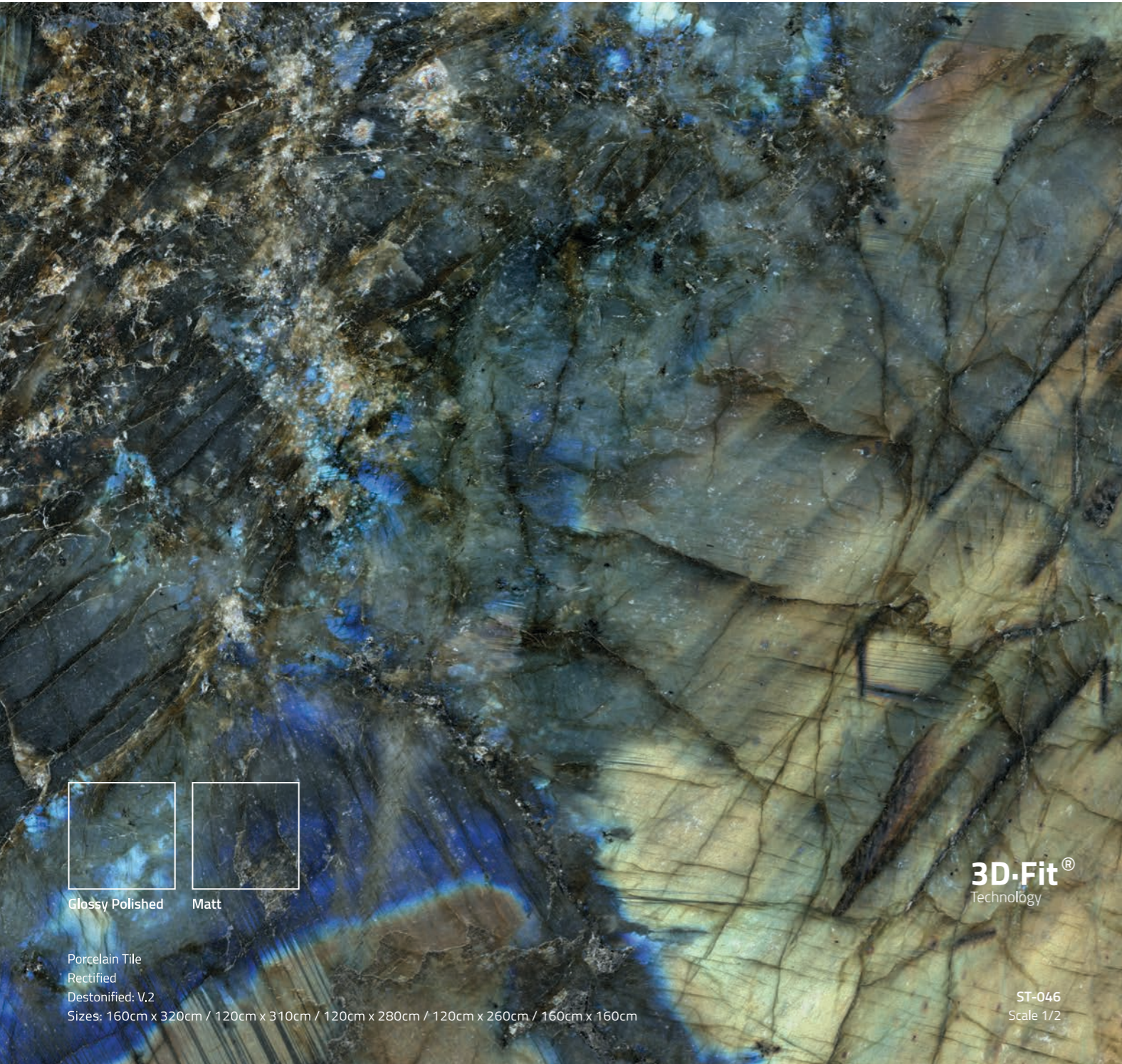

Available Sizes:

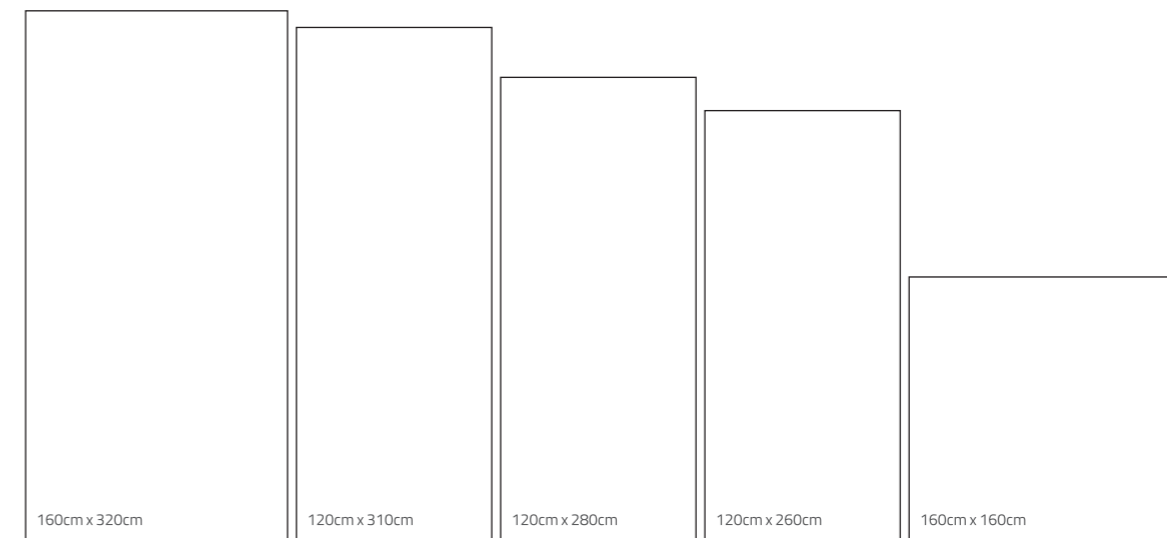

Available Colours



Green

QR Model Information:



Available Sizes & Finishes:

Normal Size	Glossy Polished	Matt	Box	Box M2	Box Kg	Pallet Pz	Pallet M2	Pallet Kg	Pallet Dimensions	Trolley Pallet	Trolley M2	Trolley Kg
160x320 - 0,9 cm	●	●	1	5.12	111	20	102.4	2357	337x177x52 cm	9	921.6	21213
120x310 - 0,9 cm	●	●	1	3.72	80	28	104.16	2390	327x137x60 cm	9	937.44	21510
120x280 - 0,9 cm	●	●	1	3.36	73	30	100.8	2322	297x137x62 cm	10	1008	23223.2
120x260 - 0,9 cm	●	●	1	3.12	67.5	33	102.96	2350	277x137x64 cm	10	1029.6	23500
160x160 - 1 cm	●	●	1	2.56	60	35	89.6	2200	177x177x71 cm	10	896	22000

ST-050

Stone



Porcelain Tile
Rectified
Destonified: V.2
Sizes: 120cm x 310cm / 120cm x 280cm

3D-Fit®
Technology

ST-050 Bone
Scale 1/2

Available Colours



Bone

Light Grey

Dark Grey

QR Model Information:



Available Sizes:

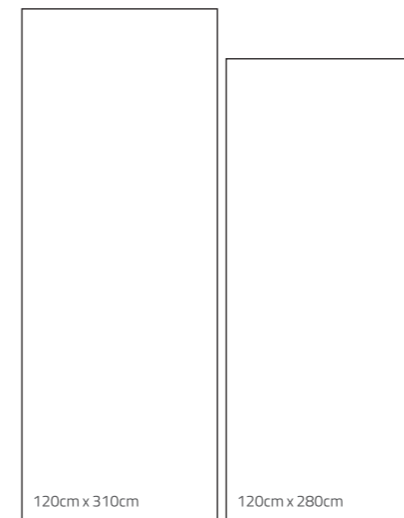

Available Sizes & Finishes:

Normal Size	Matt	Box	Box M2	Box Kg	Pallet Pz	Pallet M2	Pallet Kg	Pallet Dimensions	Trolley Pallet	Trolley M2	Trolley Kg
120x310 - 0.9 cm	●	1	3.72	80	28	104.16	2390	327x137x60 cm	9	937.44	21510
120x280 - 0.9 cm	●	1	3.36	73	30	100.8	2322	297x137x62 cm	10	1008	23223.2

WD-004

Wood

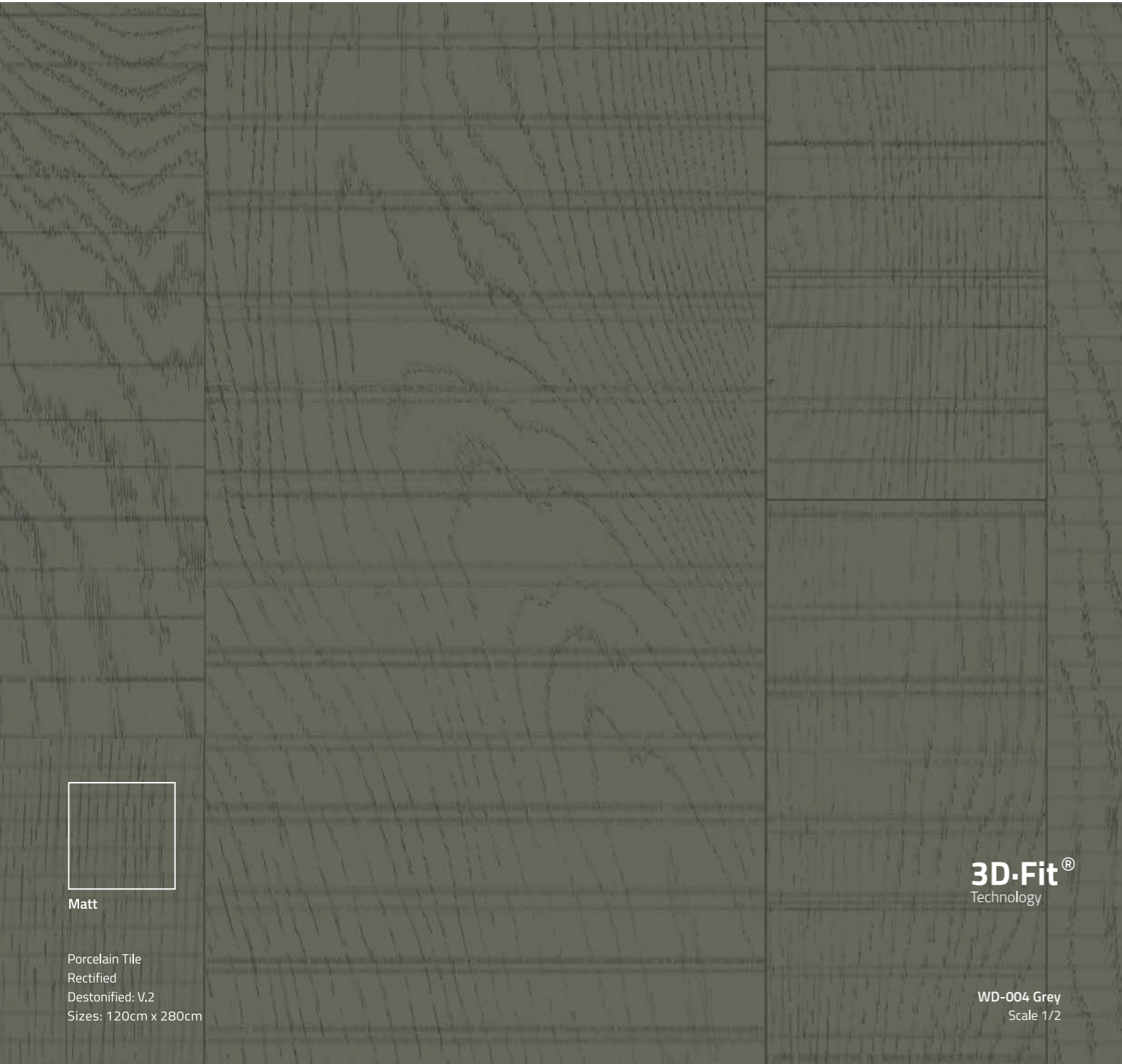

Matt

Porcelain Tile
Rectified
Destonified: V.2
Sizes: 120cm x 280cm

3D-Fit®
Technology

WD-004 Grey
Scale 1/2

Available Colours

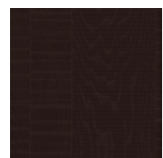

Black

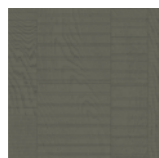

Grey

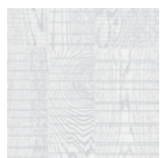

White

QR Model Information:



Available Sizes:

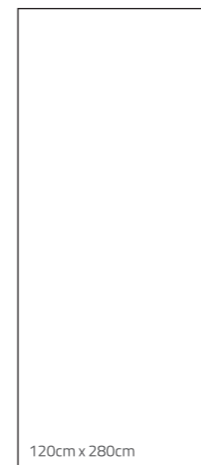

120cm x 280cm

Available Sizes & Finishes:

Normal Size	Matt	Box	Box M2	Box Kg	Pallet Pz	Pallet M2	Pallet Kg	Pallet Dimensions	Trolley Pallet	Trolley M2	Trolley Kg
120x280 - 0.9 cm	●	1	3.36	73	30	100.8	2322	297x137x62 cm	10	1008	23223.2

DATA SHEET

SYMBOLOLOGY

93

BODY



STRUCTURE

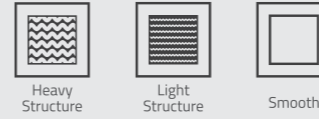

GLAZE



USAGE AREA



WEAR



LAYING

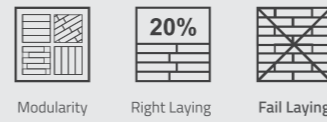

SLIP

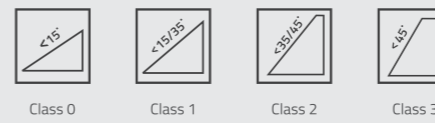

APPEARANCE

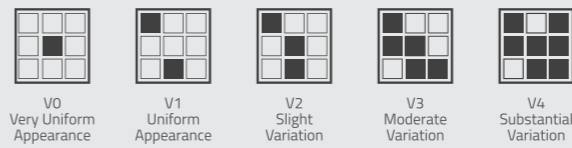

OTHERS



TECHNICAL INFORMATION

CHARACTERISTICS	ANNES G GROUP BLA Requirements for normal size N>15cm	TEST METHOD	TEST RESULT
DIMENTION AND SURFACE QUALITY			
Length and width (cm)	± 0.6% max ± 2mm	EN ISO 10545-2	Affirmative
Thickness	± 5% max ± 0.5mm	EN ISO 10545-2	Affirmative
Rectangularity	± 0.5% max ± 2mm	EN ISO 10545-2	Affirmative
Straightness of sides	± 0.5% max ± 1.5mm	EN ISO 10545-2	Affirmative
SURFACE PROPERTIES			
a) Center curvature, related to diagonal calculated from the work size	± 0.5% max ± 2mm	EN ISO 10545-2	Affirmative
b) Edge curvature, related to the corresponding work size	± 0.5% max ± 2mm	EN ISO 10545-2	Affirmative
c) Warpage, related to diagonal calculated from the work size	± 0.5% max ± 2mm	EN ISO 10545-2	Affirmative
PHYSICAL PROPERTIES			
Water absorption (%)	E < 0.5% INDIVIDUAL MAXIMUM 0.6%	EN ISO 10545-3	Affirmative
BREAKING STRENGTH (N) FOR THICKNESS > 7.5MM	NOT LESS than 1300N	EN ISO 10545-4	Affirmative
Modulus of rupture (N/mm ²)	Average: 35 N/mm ² Individual Minimum 32N/mm ²	EN ISO 10545-5	Affirmative
Impact resistance	Declared value	EN ISO 10545-6	Affirmative
Abrasion resistance of glazed tiles	Declared value	EN ISO 10545-7	Affirmative
Coefficient of linear thermal expansion	Declared value	EN ISO 10545-8	Affirmative
Resistance to thermal shock	pass according to EN ISO 10545-1	EN ISO 10545-9	Affirmative
FROST resistance	pass according to EN ISO 10545-1	EN ISO 10545-12	Affirmative
CHEMICALS PROPERTIES			
Resistance to the low concentration of acids & alkanes	Declared value	EN ISO 10545-13	Affirmative
Resistance to the high concentration of acid & alkanes	Declared value	EN ISO 10545-13	Affirmative
Resistance to household chemicals & swimming pool salts	Minimum class B	EN ISO 10545-13	Affirmative
Resistance to staining (unglazed tiles)	Declared value	EN ISO 10545-14	Affirmative

CHARACTERISTIC OF CERAMIC TILES REQUIRED FOR DIFFERENT APPLICATIONS

GLAZY TYPE	WATER ABSORPTION	SURFACE MOLD TYPE	ABRASION RESISTANCE	RESISTANCE TO STAIN	RESISTANCE TO CHEMICALS
MATT	Silica	Flat / Structure	Min 3	5	GLA
	Nature		Min 3	5	GLA
	Out door		Min 4	4	GLA
FULL LAPPATO	Bla	Flat	MIN 2	5	GLA
LAPPATO	Bla	Flat	MIN 3	4	GLA
COUNTER TOP	Bla	Flat	MIN 2	5	GLA

PACKAGING

Normal Size	Box	Box M2	Box Kg	Pallet Pz	Pallet M2	Pallet Kg	Pallet Dimensions	Trolley Pallet	Trolley M2	Trolley Kg
160x320 - 0.9 cm	1	5.12	111	20	102.4	2357	337x177x52 cm	9	921.6	21213
120x310 - 0.9 cm	1	3.72	80	28	104.16	2390	327x137x60 cm	9	937.44	21510
120x280 - 0.9 cm	1	3.36	73	30	100.8	2322	297x137x62 cm	10	1008	23223.2
120x260 - 0.9 cm	1	3.12	67.5	33	102.96	2350	277x137x64 cm	10	1029.6	23500
160x160 - 1 cm	1	2.56	60	35	89.6	2200	177x177x71 cm	10	896	22000
120x120 - 1 cm	1	1.44	34	45	64.8	1620	137x137x83 cm	14	907.2	22680

Recommendations

Slab tiles can be installed both inside and outside the house, and it is used for floor and wall. The most technical characteristics of porcelain slabs are included, the resistance against freezing, staining, surface scratches, water absorption and so on. As a matter of fact, by correct installation of slabs, the most house and commercial facility needs will be fixed.

Packaging and storage are done on wooden boxes and metal structures, and the best way to maintain the quality of the product is to keep them in the original packaging.

Installation Recommendations

- 1 CONFORMITY OF TONE AND CALIBER OF THE MATERIAL.
- 2 MAKE SURE THAT THE AREA TO CLAD IS CLEAN AND DRY.
- 3 CEMENT-BASED ADHESIVE SHOULD BE USED FOR EACH TYPE OF PRODUCT; PORCELAIN COLOR BODY OR WHITE BODY.
- 4 THE AREA TO CLAD MUST BE UNIFORMLY LEVELED. THE USE OF LEVELING SYSTEMS IS MANDATORY FOR A PERFECT INSTALLATION.
- 5 THE RECTANGULAR FORMATS CANNOT BE PLACED UNITED TO ANY MORE THAN 1/4 OF THE PIECE.

THE SLAB INSTALLATION REQUIRES THE USE OF TOOLS AND SPECIFIC TRAINING BY THE INSTALLER. IN ADDITION TO THE ABOVE, THESE ARE SOME OF THE RECOMMENDATIONS TO TAKE INTO ACCOUNT IN THE INSTALLATION OF LARGE TILE FORMATS:



CUTTING DETAIL WITH GUIDE ON SLAB



THE TILES PROPERTIES MAKE THEM EASY TO CUT

- 6 THE DOUBLE BONDING TECHNIQUE MUST ALWAYS BE USED.

THE SLAB INSTALLATION REQUIRES THE USE OF TOOLS AND SPECIFIC TRAINING BY THE INSTALLER. IN ADDITION TO THE ABOVE, THESE ARE SOME OF THE RECOMMENDATIONS TO TAKE INTO ACCOUNT IN THE INSTALLATION OF LARGE TILE FORMATS:

- 7 THIS MATERIAL REQUIRES THE USE OF C2 CLASS ADHESIVES (BICOMPONENT TYPE S2).
- 8 THE APPEARANCE OF AIR POCKETS BETWEEN TILE AND SUBSTRATE SHOULD BE AVOIDED BY THE SYSTEMATIC KNOCKING OF THE TILE WITH A RUBBER TROWEL. THIS WILL AVOID TENSIONS AND BREAKS AFTER THE MATERIAL HAS BEEN SET.
- 9 THE USE OF SPECIFIC TOOLS FOR INSTALLING CERAMIC TILES IS MANDATORY. CONSULT YOUR TRUSTED SUPPLIER TO RECEIVE INSTRUCTIONS ON THE CORRECT HANDLING OF THESE TOOLS AND THEIR NEEDS.

Big Slab Installation Video



PLAY VIDEO

General Transport Advice



ATTENTION

LOAD WITHOUT TRANSPORTER IS NOT RECOMMENDED. IT IS ESSENTIAL TO READ THE UNE138002 & UNE12004 STANDARD, TO ACHIEVE A CORRECT PLACEMENT OF THE CERAMIC TILE. ALWAYS USE SPECIFIC TOOLS FOR MOVING THE SHEETS.

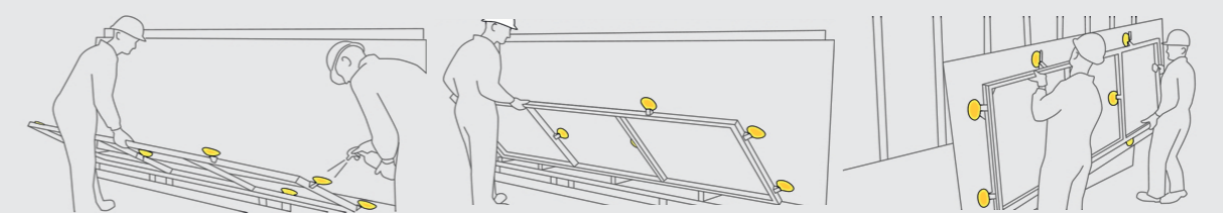

HANDLING AND SETTING OF A SLAB BY USING SUCTION FRAME

LOAD FROM CENTER NOT ALLOWED

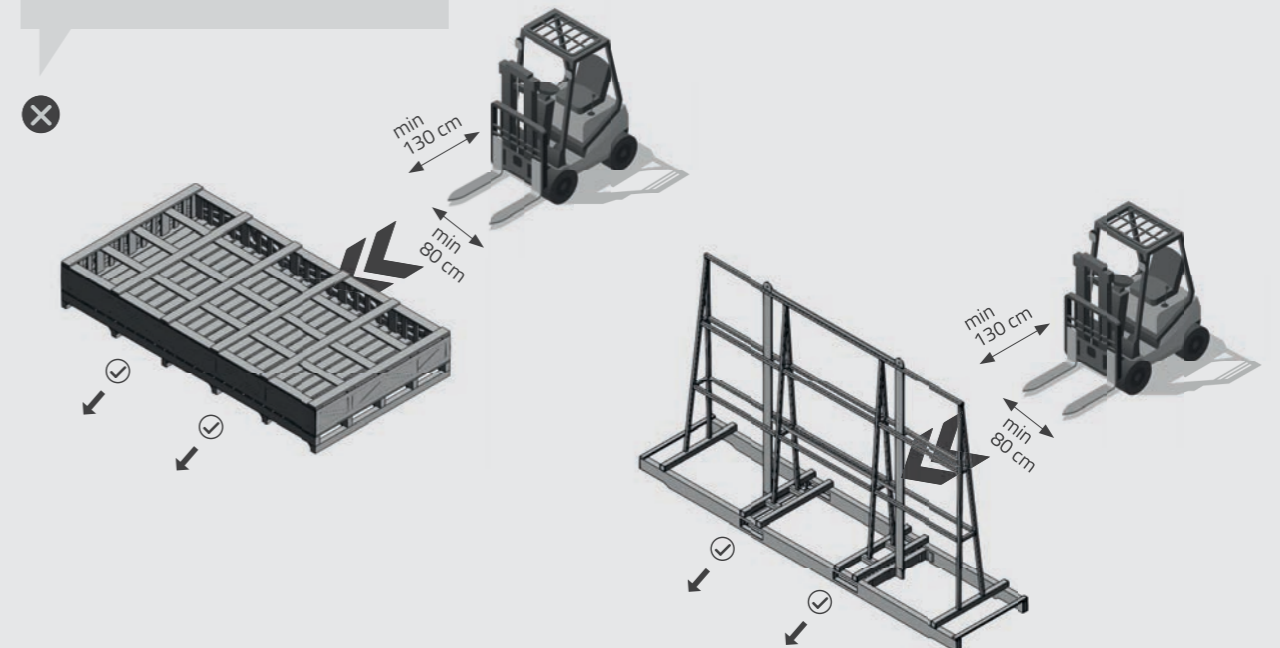

Installation

The place where the slab is installed is important to correct installation.

Before starting the installation stage, it is best to check the following characteristics of all types of substrates:

- Be sure that, it is free of any grease, oil or dust.
- It is essential to fill any gaps in level by using the proper leveling devices.
- The flat installation surface has a very important effect on reducing the amount of glue used during installation and it also prevents surface cracks.
- The surface should be completely smooth and without any cracking.



GLUING THE SLAB

GLUING THE SUPPORT

COMPLETE GLUING

Installation Method

According to the preparation method mentioned in the package, after preparing the glue by using a mixer, apply it continuously. In the first step, the glue is applied to the back of the slab (with a 3-4 mm trowel) then repeat the same amount of it on the surface of the slab placement (with a 10 mm trowel).

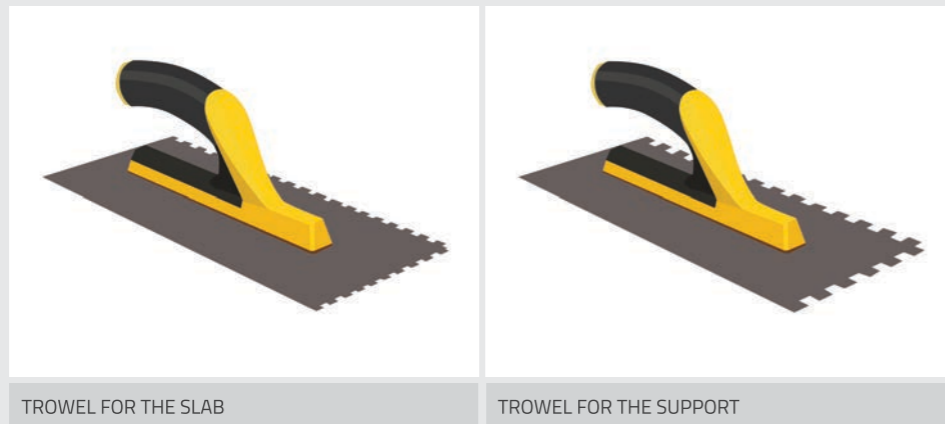

TROWEL FOR THE SLAB

TROWEL FOR THE SUPPORT

According to the picture below, the correct way for applying glue is shown.

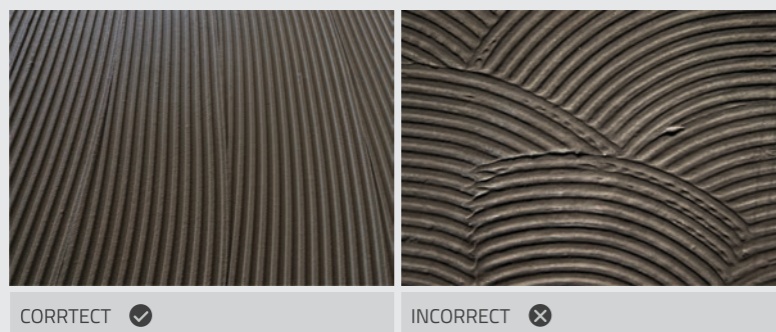

CORRECT ✓

INCORRECT ✗

Setting

Once both surfaces are ready to be installed, then place the Tabriz tile group slab into the final installation position.

FLOORING

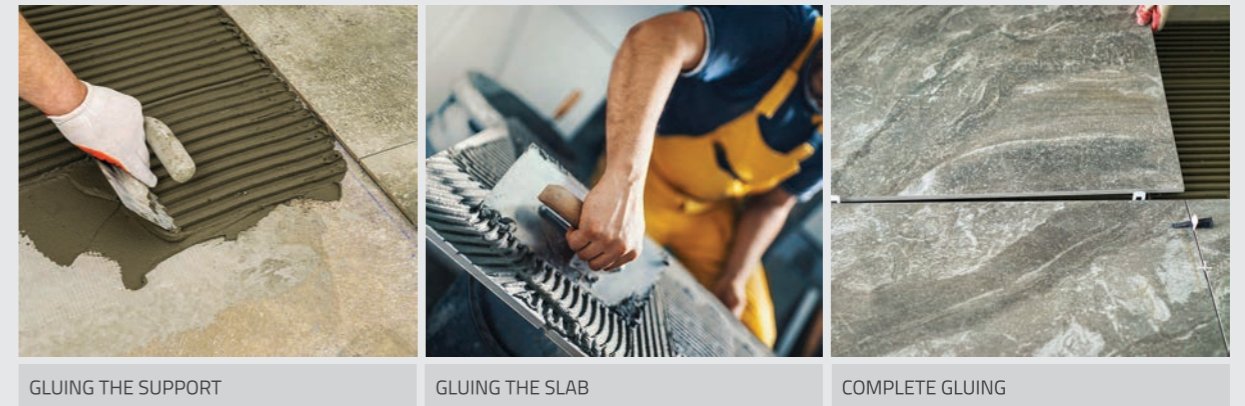

GLUING THE SUPPORT

GLUING THE SLAB

COMPLETE GLUING

WALLS

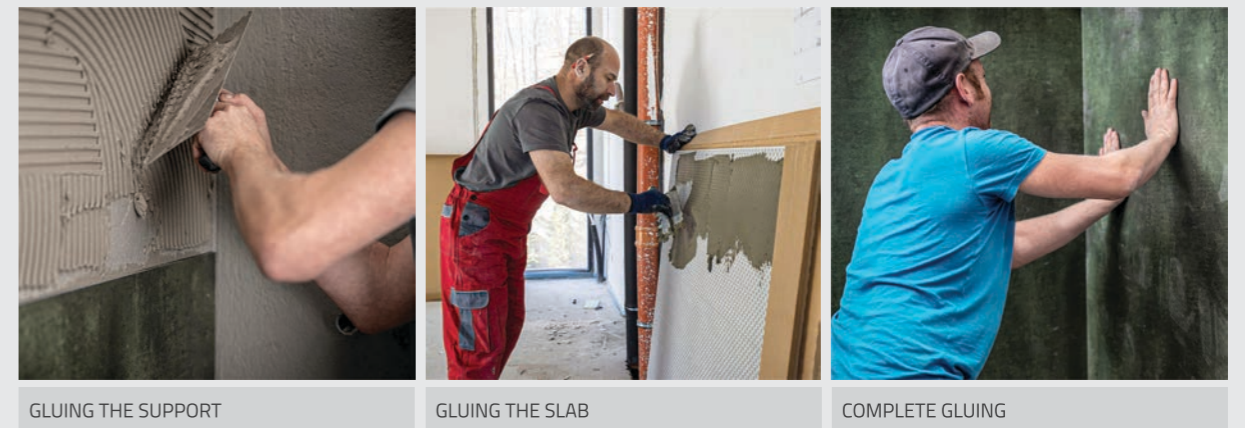

GLUING THE SUPPORT

GLUING THE SLAB

COMPLETE GLUING

After installation, in order to remove gaps and air bubbles between the slab and the installation surface, a vibrating device should be used.



According to the picture below, the best way to be sure that the slabs were placed in the right position, is to use the wedges and supports system. Using this method make the slabs more firmly stuck to the glue and also reduces the installation time.



LEVELLING

In order to have the best installation quality of slab products, use wedges and supports system at a distance of 40-50 cm from each side, after applying glue.

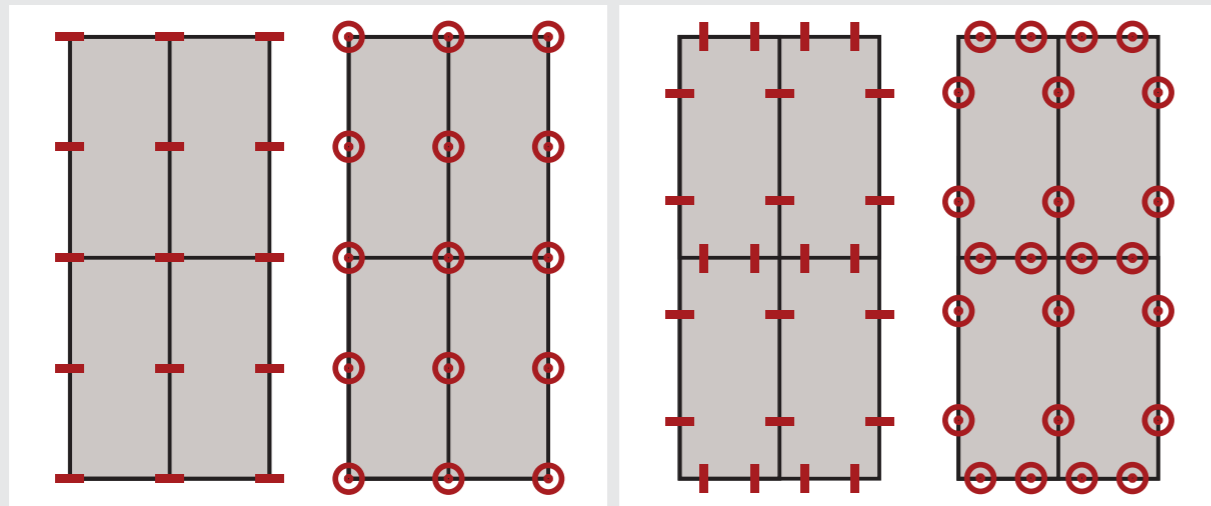

For using the best condition of wedges and supports system, it is recommended to install them in the middle and in the opposite direction of each other. In this condition the pressure is applied equally to both slabs at the same time. And also note that, it is important to use a Grouting to the thickness of at least 2 mm.



SUPPORTS

Grouting

Grouting should be done with powder (antibacterial). If the broken part of the support remains inside the grouting, before pulling the grouting material, use a steel plate to completely empty the grouting (the best way is using adhesive tape on both sides of the grouting).

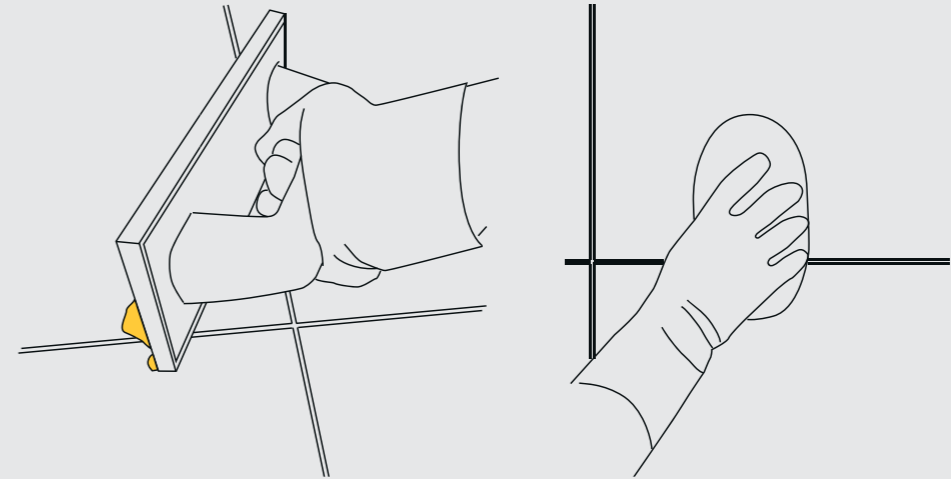

GROUTING PIECES

CLEANING

Cleaning & Maintenance

Once placed and grout cleaning equipment is mandatory. Improper cleaning may leave traces of products used in the placement or the protection of the tiles, as cements, resins epoxilicas, grout, waxes or fats. For optimal cleaning after placement for cases of intense and stubborn dirt accumulated over time, and for maintenance, required to use the right products. The following table shows some of the recommendations.

TYPE OF STAIN	RECOMMENDED CLEANING PRODUCT
Cement and lime wastes	Diluted organic acids (vinegar) or alkaline-based detergents.
Oxide remnants	Phosphoric acid or acid-based detergents.
Oils	Ethyl alcohol or alkaline-based detergents.
Greases	Diluted organic acids (vinegar) or alkaline-based detergents.
Inks	Diluted sodium hypochlorite (bleach) or acid detergent.
Coffee	Dilute solution of sodium hypochlorite or alkaline detergents.
Rubber	Organic solvents (trichlorethylene, thinner).
Paint	Specific solvent or paint stripper.
Tar	Trichloroethylene.
Fruit juices	Sodium hypochlorite (bleach).
Permanent marker	Organic solvents (acetone, trichlorethylene).
Aluminum mark	Acid detergent.
Blood	Hydrogen peroxide (h2o) or sodium hypochlorite.



Main office:
No 7, Saman st, Mollasadra Ave,
Vanak sq, Tehran, Iran

Tel: (+98) 21 88062050

 www.shahidico.com

 [@shahidi.co](https://www.instagram.com/shahidi.co)

